

# INSTALLATION INSTRUCTIONS

## "J" CLASSIC COMMERCIAL FINNED-TUBE RADIATION JVA/JVB-AR L/EI

1. Determine quantities of enclosure and accessories required per wall or run. If installation is wall-to-wall, run backplate to within ½" of adjoining wall(s). If run ends with end cap, extend backplate beyond end of required enclosure 1-1/2" for 4" end and 6" for 8-3/8" end.
2. Mount backplate (full or partial) to wall at prescribed height (Refer to Submittal Drawing) making sure that it is level. If valve compartments are being used, make sure that an equivalent amount of backplate is installed.
3. Install extruded aluminum floor angle to the floor at the dimension out from the wall as shown on submittal drawing. The floor angle will run continuously; the full length of the run.
4. **Hot Water Systems or Steam Systems (Two Pipe):** Vertical wall brackets are used with bracket mounted hangers to support the element(s). Hot water systems do not require pitch for the element. If a second tier (row) of element is to be installed, mount the bracket mounted hangers to the vertical wall bracket using the 5/16-18 carriage bolt and nut supplied before installation of the vertical brackets to the wall. Install two (2) vertical brackets per element length up to 6'-0" of length. Three (3) vertical brackets with bracket mounted hangers per element length 6'-6" up to 12'-6" (8'-0" for ¾" copper/aluminum) of length. (Accessories do not require brackets). Insert top of the bracket into 'V' bend of backplate (Full or Partial) and insert onto horizontal flange of the partial backplate. Secure brackets to wall using fasteners (as specified) by others. Supply/Return Pipe hangers (if required) can be mounted to the wall adjacent to the water bracket (every other one).
5. Lay out heating element as required. Place slide cradle onto the bottom of element at each bracket location. The element cradle has two legs that angle out slightly. Position the legs between the fins so there is tension against the legs. This holds the cradle in position. For Two Pipe Steam systems adjust element pitch by raising the bracket mounted hanger and tighten nut to secure hanger into position. Water brackets do not provide pitch for bottom tier of element. Second tier elements mounted on the bracket-mounted hangers can be adjusted up or down. Check submittal drawing for correct position of element fin. **For copper tube elements, flush the loop or series with system water after soldering to neutralize the remaining flux material and prevent corrosive action and resulting pinhole leaks.**
6. The enclosure can now be installed, unless damper assembly is required (see damper installation sheet packed with damper blades). Start enclosure at left end of run, working clockwise. The enclosure grille support gussets mount directly into the 'V' bend of backplate. Slip the bottom edge of the enclosure front panel into the receiving slot of the extruded aluminum floor angle. Firmly push next piece of enclosure into slip joint tabs of piece on left until run is completed. The enclosure can be secured to the floor angle if desired with fasteners by others.
7. Install overlapping accessories as indicated on room schedule. All accessories are overlapping. Valve Compartments are installed the same as enclosure. The top back bend is slipped between the wall and the backplate. The accessory bottom extends to the floor and is secured with fasteners by others.

### MAINTENANCE

Before each heating season, remove accessories and enclosure panel to inspect finned tube elements for accumulation of dust or other debris that may accumulate and block airflow between fins. Remove dust and debris from coil fins with a vacuum cleaner or compressed air. Inspect for leaks or areas of corrosion. It should not be required, but if necessary, place a drop of lubricant (machine oil) onto each ball bearing (where applicable) located in the water brackets or bracket mounted hangers. Replace cover and accessories.



260 North Elm St., Westfield, MA 01085 Tel: (413) 564-5535 Fax: (413) 562-8437  
www.sterlingheat.com



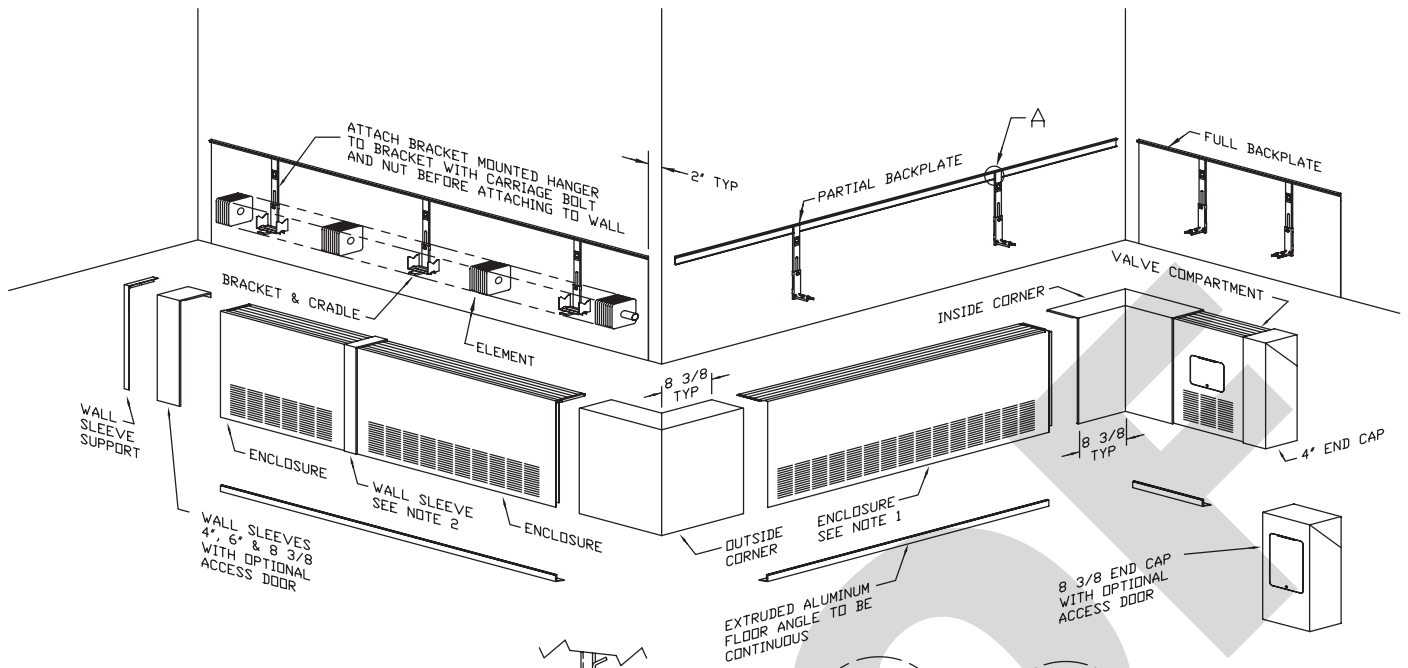

**NOTES:**

- ENCLOSURE SECTIONS AVAILABLE IN FOLLOWING STANDARD LENGTHS: 2' THRU 8' IN 6" INCREMENTS. CONSULT FACTORY FOR SPECIAL LENGTHS.
- WALL SLEEVES MAY BE AT ENDS OR PLACED IN RUN FOR DIMENSIONAL MAKE-UP.
- FOR DAMPER INSTALLATION SEE DAMPER INSTRUCTION SHEET.

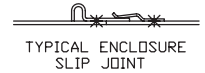
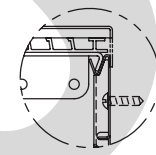
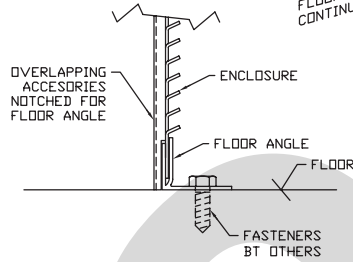

CAT-64444C

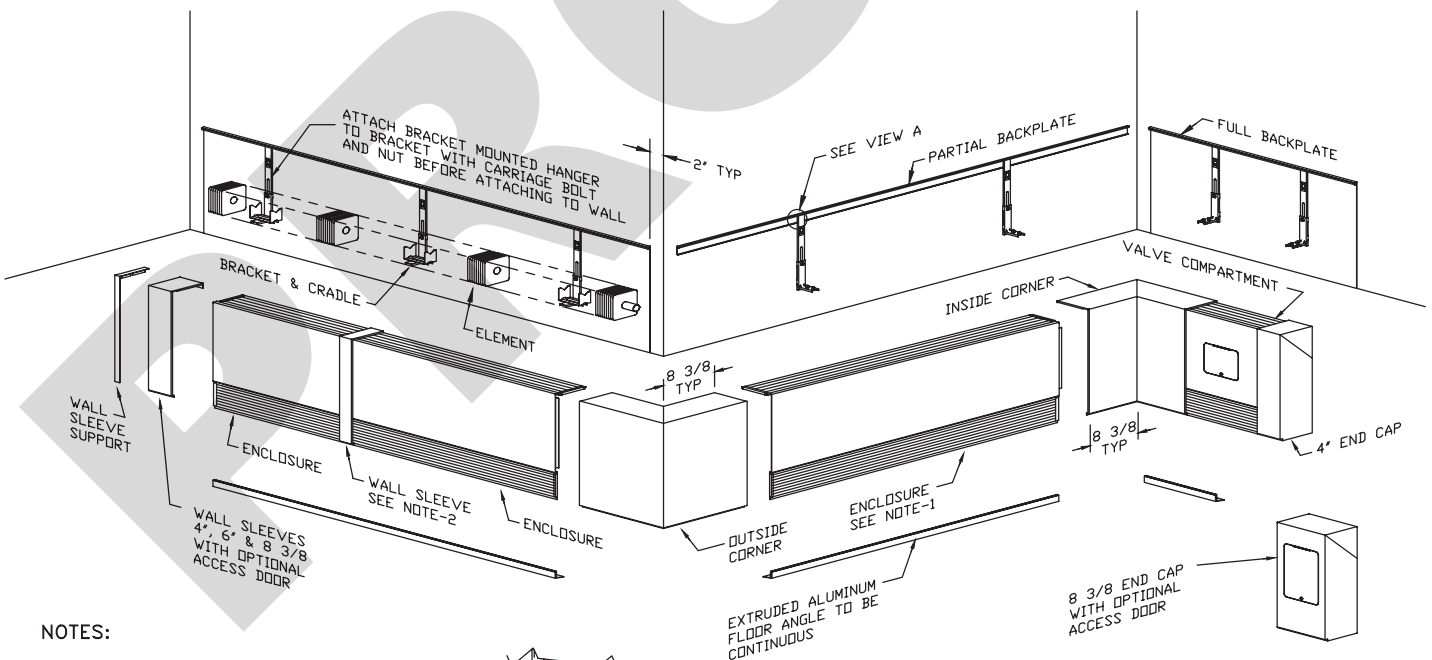

**NOTES:**

- ENCLOSURE SECTIONS AVAILABLE IN FOLLOWING STANDARD LENGTHS: 2' THRU 8' IN 6" INCREMENTS. CONSULT FACTORY FOR SPECIAL LENGTHS.
- WALL SLEEVES MAY BE AT ENDS OR PLACED IN RUN FOR DIMENSIONAL MAKE-UP.
- FOR DAMPER INSTALLATION SEE DAMPER INSTRUCTION SHEET.

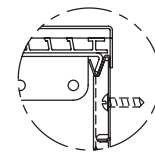
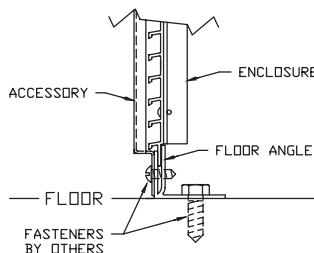

CAT-71269B