

HEAT PUMP

		Units	HP0275
Cooling	Capacity Range	BTU/hr	96,035-353,225
	Efficiency Range	EER	7.44-18.68
	Efficiency	IPLV	17.1
	Delivered Water Temp Range	°F	41-86
	Ambient Temp Range	°F	5-131
Heating	Capacity Range	BTU/hr	52,543-541,382
	Efficiency Range	COP	1.46-7.64
	Delivered Water Temp Range	°F	59-140
	Ambient Temp Range	°F	-22-109.4
	CEC Data	Cooling Capacity*	BTU/hr
	Cooling Efficiency*	EER	8.95
	Heating Capacity**	BTU/hr	274,965
	Heating Efficiency**	COP	8.3
	Heating Capacity***	BTU/hr	187,254
	Heating Efficiency***	COP	6.2
Electrical	Power	V/Ph/Hz	460/3/60
	Fan Motor	A	4.0×2
	Compressor Motor	A	23.0×2
	MCA	A	60
	MOPD	A	70
	SCCR	kA	10
	Refrigerant	Type	
	Factory Charge	lbs.	19.84×2
Fan	Quantity		2
	Power Input	W	550
	Type		DC
Sound (@3meters)	Max Speed	RPM	800
	Range	dBa	54-67
	Rated Flow	GPM	52.83
Hydronic	Max Water Temp	°F	140
	Piping Connections	inch	2.5
	Rated Pressure Drop	PSI (ft.W.C.)	10.15
	Compressor	Type	
	Speed Range	Hz	30-120
	Brand		Hitachi
	Quantity		2
Dimensions	Net Dimensions (L x W x H)	inch	85.4×45.3×83.9
	Shipping Dimensions (L x W x H)	inch	86.6×52.2×88.2
	Net Weight	lbs.	1,616
	Shipping Weight	lbs.	1,709

CEC is California Energy Commission. Data is tested in accordance with AHRI 550/590

*= 44F LWT 54F EWT @10 GPM & 95F DB Ambient

**= 120F LWT 107F EWT @10 GPM & 47F DB Ambient

***= 120F LWT 110F EWT @10 GPM & 17F DB Ambient

Heat pump dimension and view

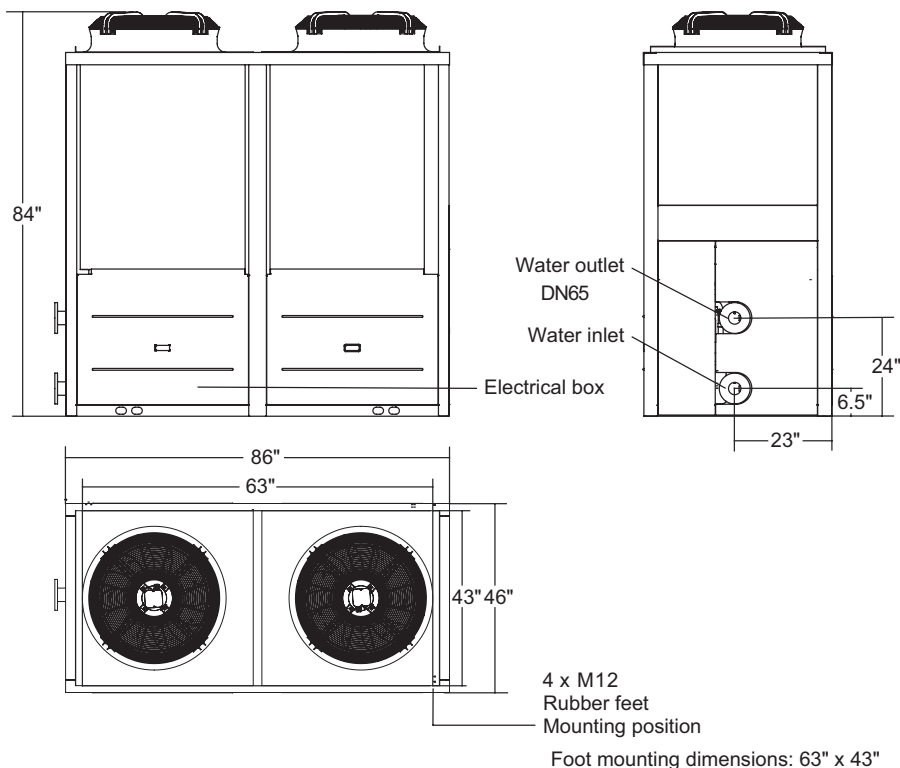

Heating Performance

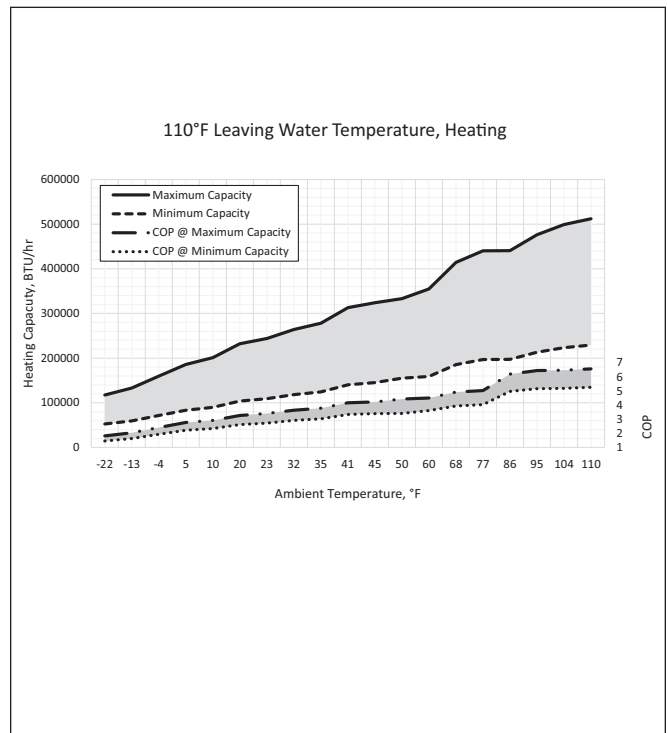
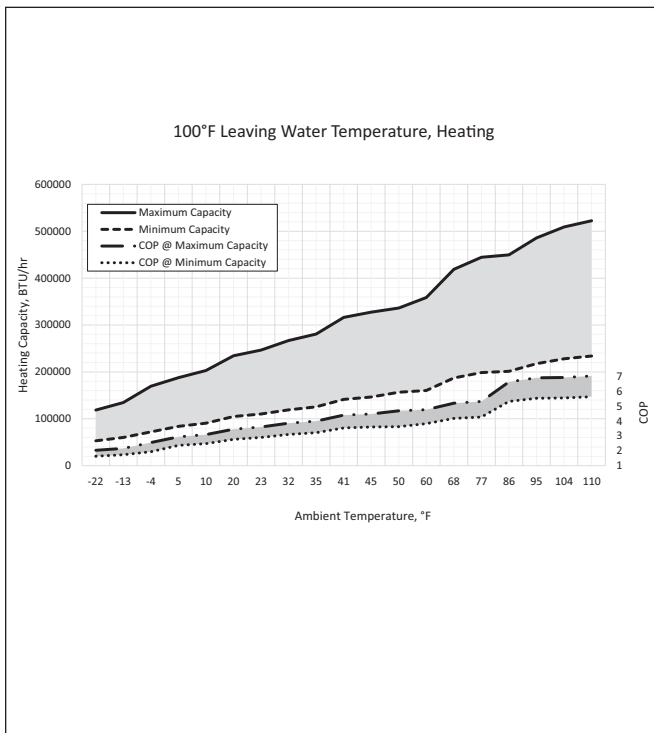
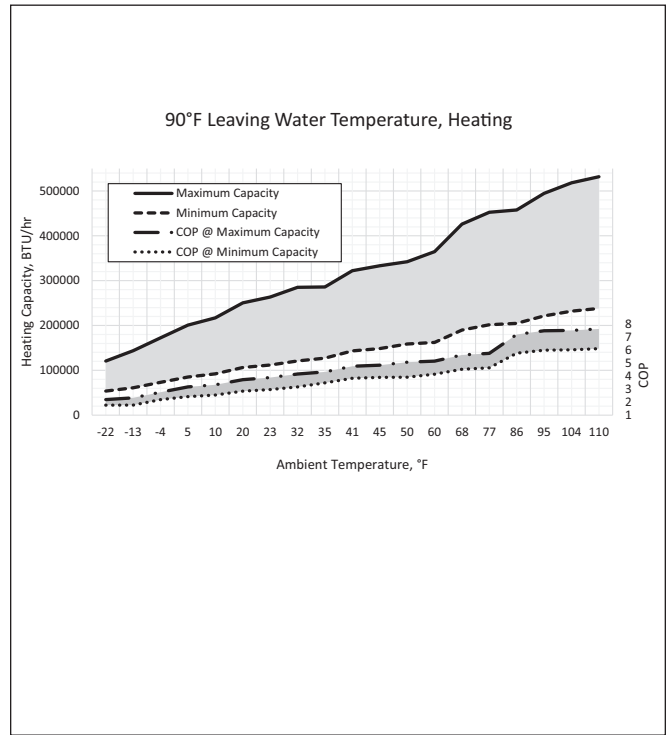
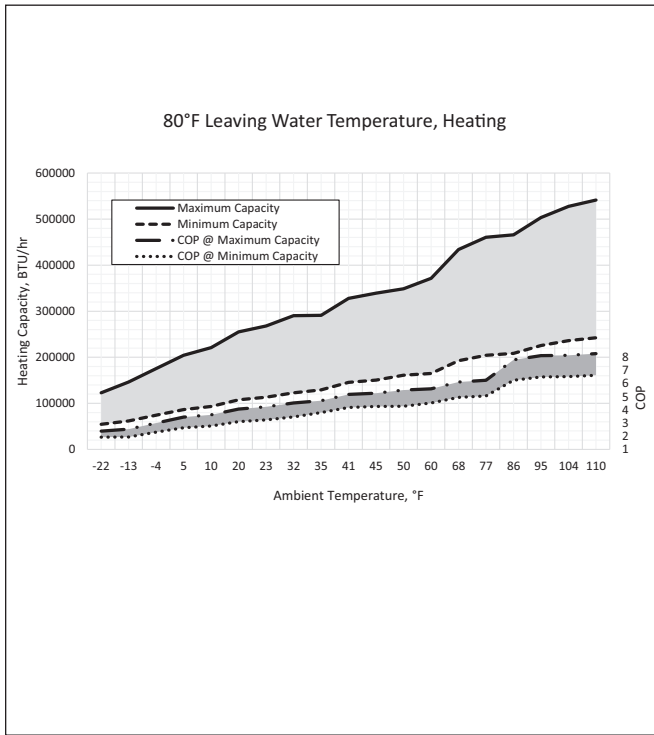

Heating Performance

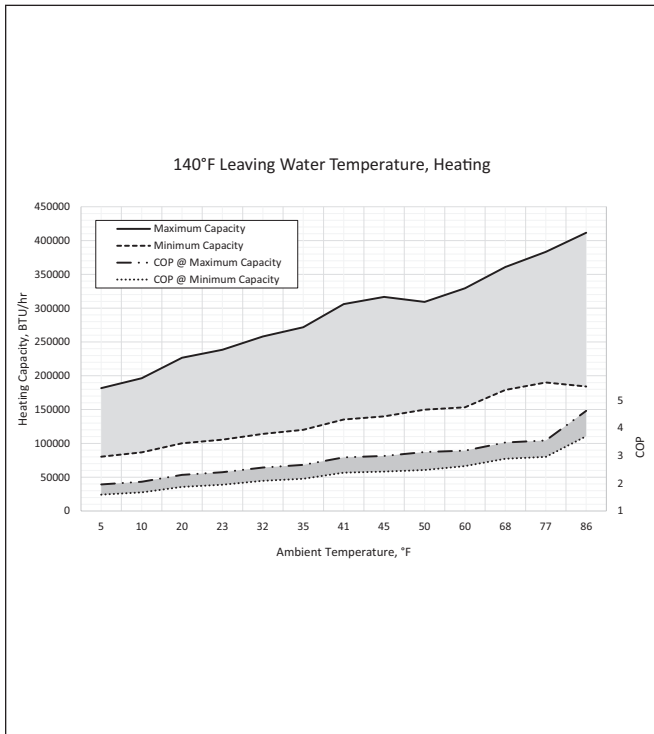
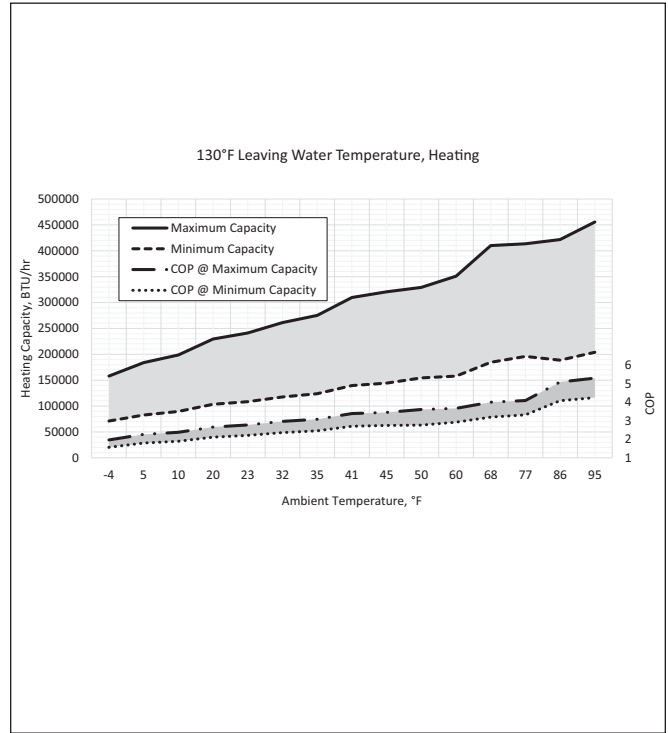
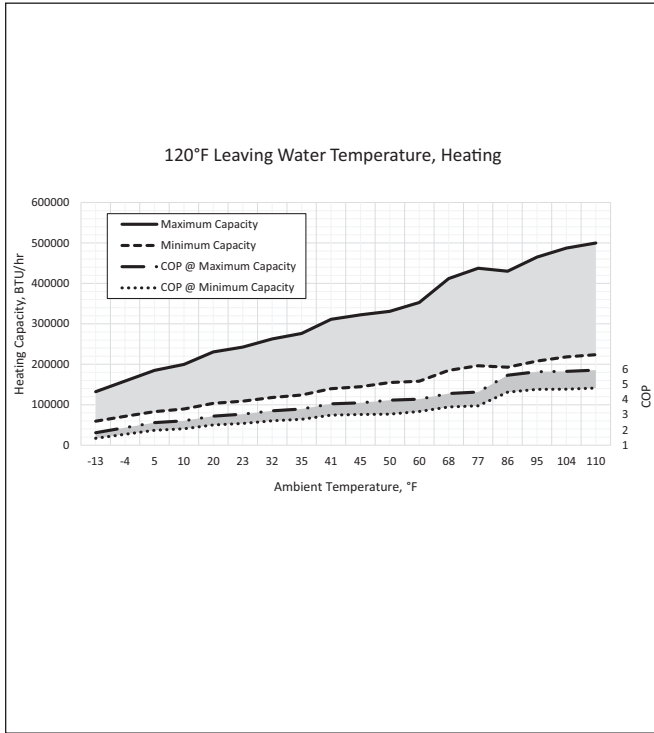

Cooling Performance

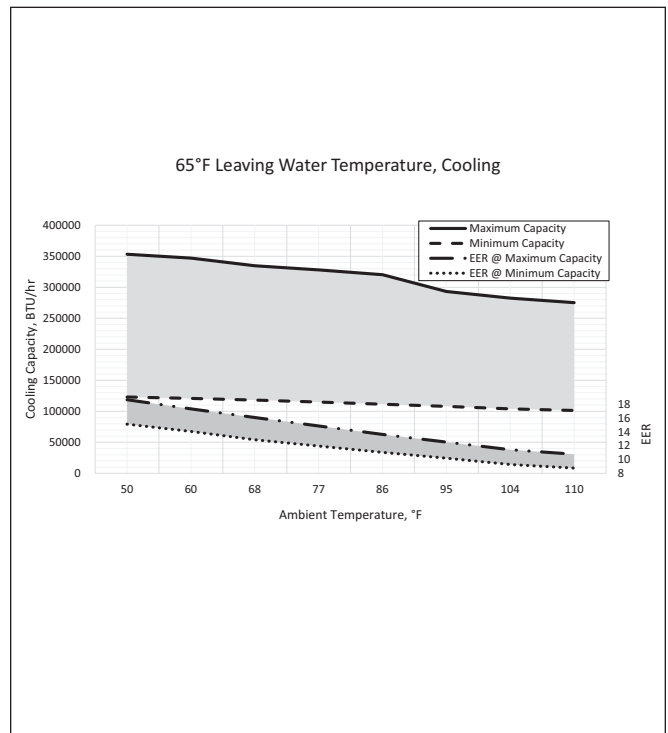
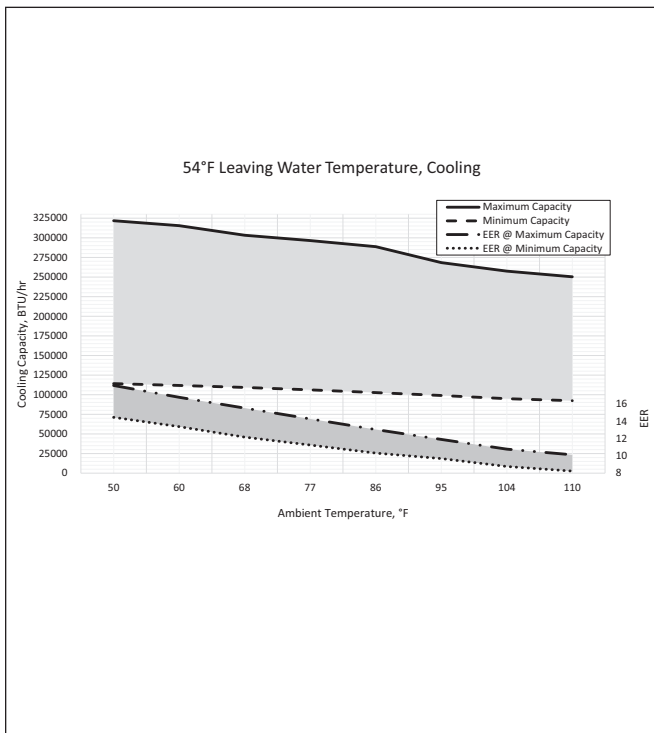
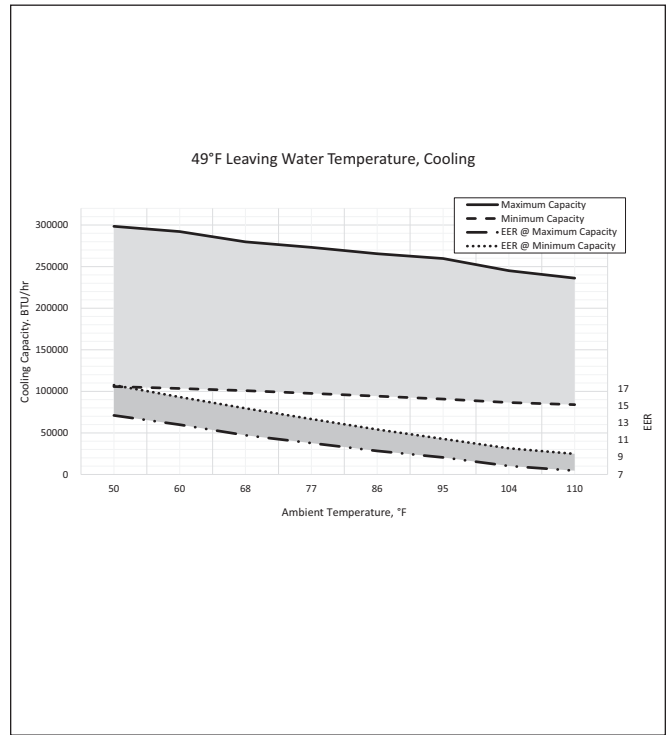
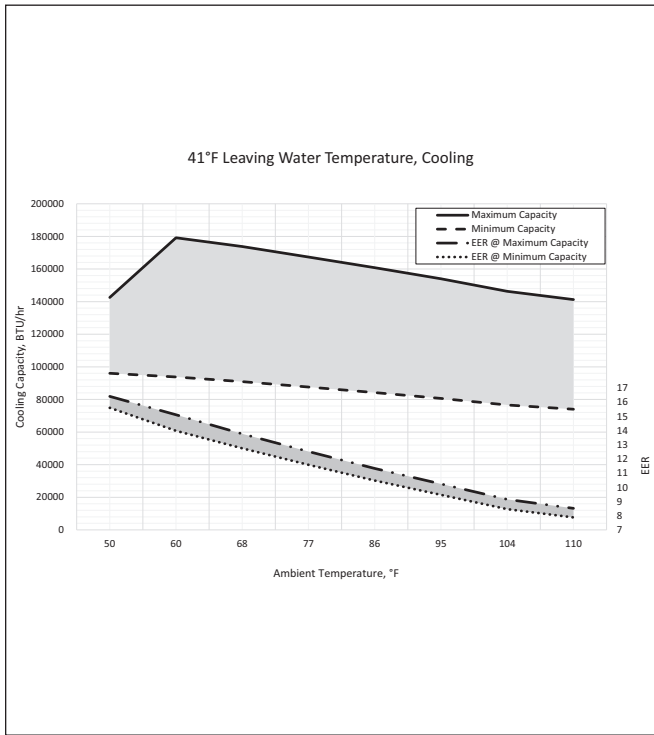

REP FIRM _____
SUBMITTED BY _____
JOB NAME _____
ARCHITECT _____
ENGINEER _____
CONTRACTOR _____
DATE _____

HEAT PUMP



A Division of Mestek, Inc.
Westfield, MA 01085
(413) 564-5515