

DOMINATOR 900

Category I or Category III Appliance

(see Installation and Operation Manual for venting information)

CODE OPTIONS

CSD-1

UTC Lockout/Reset Control
Manual Reset LWCO

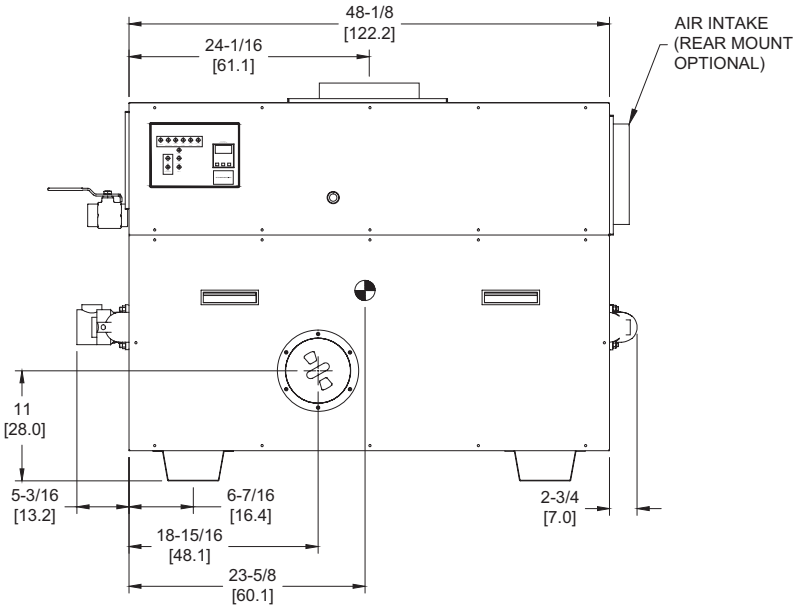
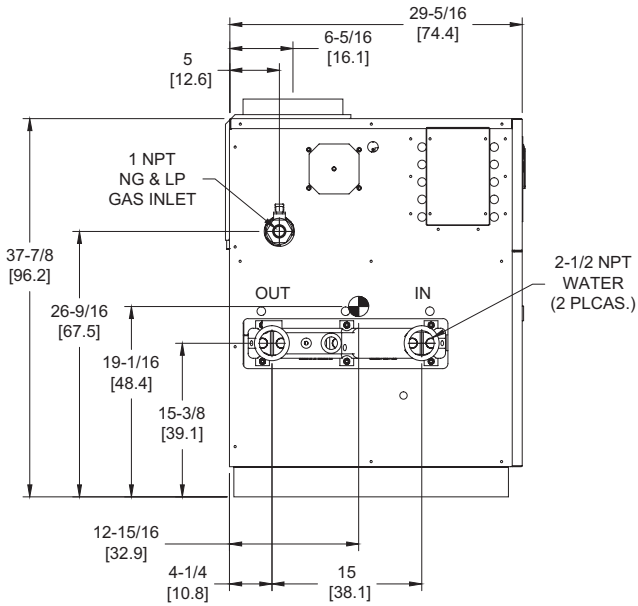
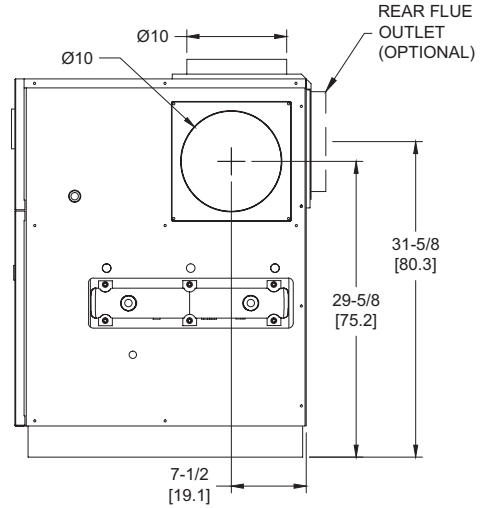
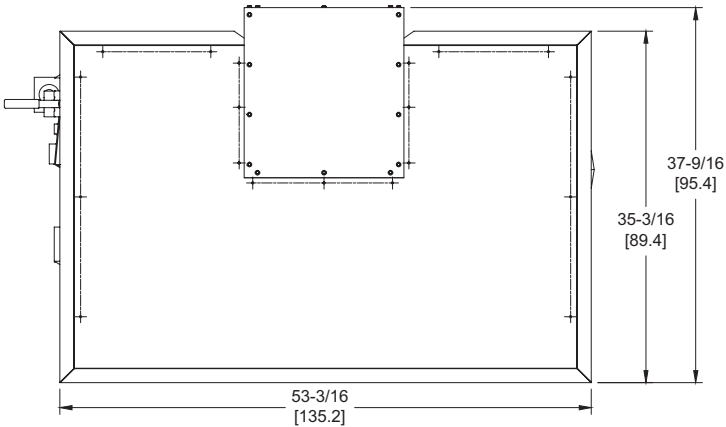

RSUB-31-E

Notes:

1. Dimensions are approximate and should not be used to "rough-in" equipment.
2. Dimensions are subject to change without notice.
3. All dimensions are in inches (cm).
4. ● Symbol indicates center of gravity.

BOILER CERTIFIED RATINGS & CAPACITIES

Fuel Type	Natural/Propane Gas	Boiler FLA	5.9*
Input BTU/hr.	900,000 / 264 kW	Min. Gas Pressure Required	7" WC**
Output BTU/hr.	765,000 / 224 kW	Max. Gas Pressure Allowed	14" WC
Electrical Requirements	120VAC/ 1 ph/ 60 hz	Operating Weight	664 lbs. / 301 kg.

BOILER / WATER HEATER TRIM & CONTROLS

Main Gas Valve	Honeywell V8944 1"	Pilot Valve	Honeywell VR8205
Firing Valve	Honeywell B200T1033 1"	Air Switch	Cleveland RSS-495
Safety Valve	ASCO L8214G 1"	Blower Motor	1/4 hp - FLA 5.1
Ignition Control	UTC 1003-61A	Relief Valve - DW	3/4" x 3/4" set @ 125 psi
Operating Control	Tekmar BTC-2PA	Relief Valve - DB	3/4" x 3/4" set @ 50 psi
High Limit	Honeywell L4008E	Flow Switch	TACO

A.S.M.E.

ASME Sect IV Htg Surface	90.0 Sq. Ft. / 8.36 Sq. M.	Design Data	Max. 160 psig & 250°F
Water Volume	4.1 gal / 15.4 Liters		

* Add circulator amps.

** For incoming gas pressures lower than 7" WC natural or 11" WC propane, consult factory.

BOILER TEMPERATURE RISE / PRESSURE DROP

20°F / 11.1°C				25°F / 13.9°C				30°F / 16.7°C				35°F / 19.4°C			
Flow Rate		Pressure Drop		Flow Rate		Pressure Drop		Flow Rate		Pressure Drop		Flow Rate		Pressure Drop	
GPM	L/s	Ft	kPa	GPM	L/s	Ft	kPa	GPM	L/s	Ft	kPa	GPM	L/s	Ft	kPa
76.5	4.8	2.25	6.6	61.2	3.9	1.49	4.4	51.0	3.2	1.06	3.1	43.7	2.8	0.80	2.4

WATER HEATER HOURLY RECOVERY CAPACITY (GPH & LPH)

40°F	22°C	60°F	33°C	80°F	44°C	100°F	56°C	120°F	67°C	140°F	78°C
2228	8423	1486	5616	1114	4212	891	3369	743	2808	637	2407

REP FIRM _____
SUBMITTED BY _____
JOB NAME _____
ARCHITECT _____
ENGINEER _____
CONTRACTOR _____
DATE _____

DOMINATOR 900

Category I or Category III Appliance
 (see Installation and Operation Manual for venting information)

RBI®
 RELIABLE. BOLD. INNOVATIVE.

A Division of Mestek, Inc.
 Westfield, MA 01085
 (413) 564-5515