

For clean air applications only

STANDARD CONSTRUCTION

FRAME: 2" x 10" x 2", 12 GA. galvanized steel formed channel frame.

BLADE: .080" (nominal) minimum thickness extruded aluminum, 8" wide airfoil blade.

SHAFT: 3/4" dia. plated steel stub shaft with a positive interlock into blade section.

LINKAGE: 12 GA. formed galvanized steel. Trunnion is a machined pivot of plated steel with a 1/2" dia. plated steel interconnecting rod.

BEARINGS: Sintered stainless steel oilite flanged sleeve, bolted to frame.

OPERATOR: Manual hand quadrant or lever arm for motor actuator. Specify type when ordering.

FINISH: Mill.

TEMP. LIMIT: 400°F

Consult the factory for temperature limits over 400°F.

OPTIONS

Jamb Seals - Stainless steel

Blade Edge Seals - Stainless steel

Flanges other than the standard 2" wide

Finishes - Acrylic, baked enamel, etc.

Perimeter holes: one flange or two flanges

Other types of bearings

Materials - stainless steel, extruded aluminum, galvanized steel, etc.

NOTES

1. 1/4" nominal deduction will be made to the opening size given.
2. Construction may be with other materials when required to meet special conditions, such as: temperature, pressure, velocity, system environment, or other specifications.
3. Approximate shipping weight is 15 lbs./sq.ft.

DAMPER SIZES

Min. Size	Max. Size
12"W x 8 1/4"H (Single Blade)	60"W x 96"H
12"W x 16"H (Opposed)	

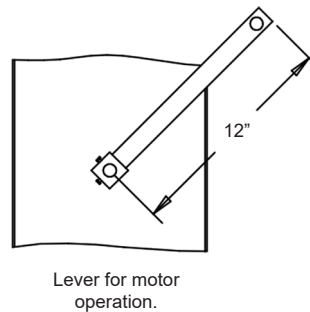
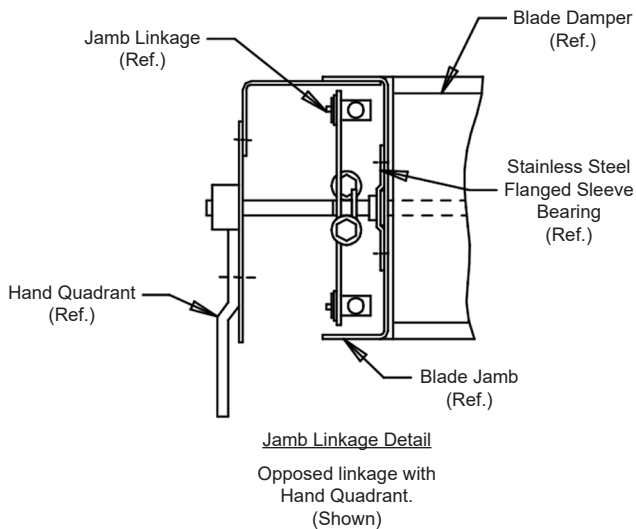
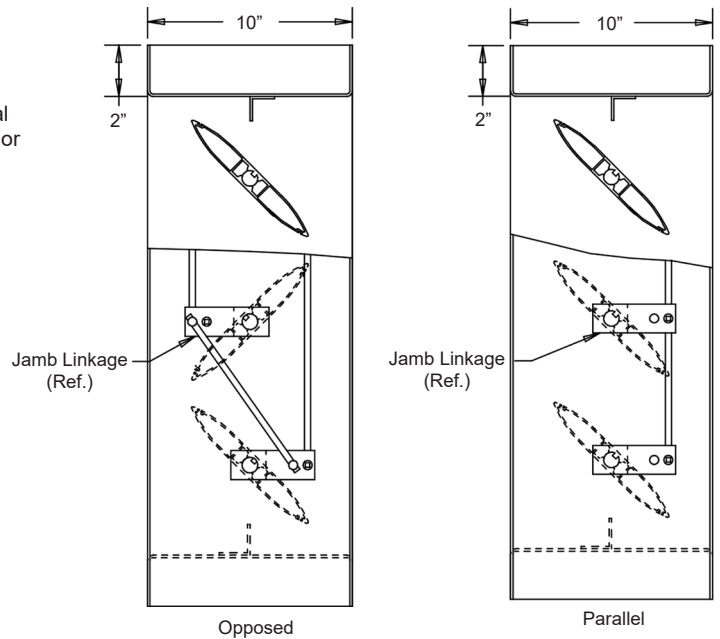
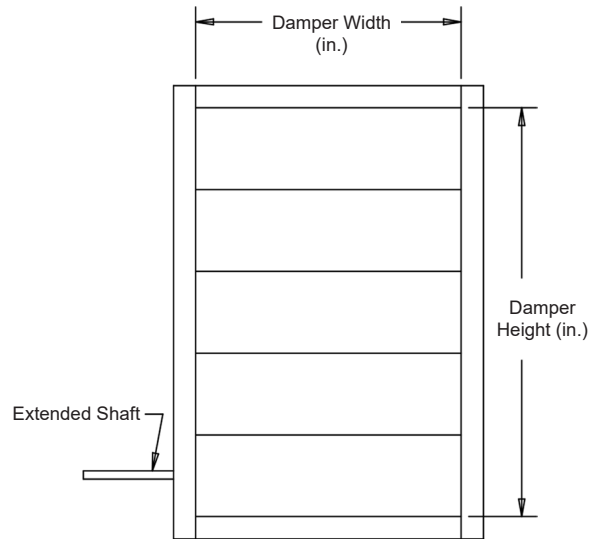

For handwritten orders, use the schedule block on page 4.

In the interest of product development, Louvers & Dampers reserves the right to make changes without notice.

www.louvers-dampers.com

450 Riverside Drive • Wyalusing PA, 18853 • Phone 570-746-1888 • Fax 570-746-9286

AIR LEAKAGE DATA

Air leakage quantities shown in the chart are results of tests per AMCA Standard 500 and are shown at 1 in. w.g. differential pressure and are corrected to .075 lb./cu.ft. air density.

Air Leakage (Total CFM)

		Damper Width (in. I.D.)								
		12"	18"	24"	30"	36"	42"	48"	54"	60"
Damper Height (in. I.D.)	12"	12	16	20	22	24	28	32	34	36
	24"	20	24	28	32	36	42	48	49	50
	36"	30	35	42	48	54	57	60	68	75
	48"	40	44	48	54	60	70	80	90	100
	60"	50	55	60	67	75	87	100	112	125
	72"	60	65	65	80	90	105	120	135	150
	84"	70	77	84	95	105	122	140	158	175
	96"	80	88	90	108	120	140	160	180	200

For determining leakage values greater than 1 in. w.g. to a maximum of 10 in. w.g., use the multiplier correction chart below.

Static Pressure (in.)	2	3	4	5	6	7	8	9	10
Multiplier Correction Factor	1.3	1.5	1.6	1.8	2.0	2.3	2.6	2.8	3.0

Air leakage ratings are based on AMCA Standard 500, using test set-up Fig. 5.4 with a damper closing torque applied to the damper of 31 in. lbs./sq.ft. of damper face area for a 60" x 96", with a minimum of 45 in. lbs./sq.ft. of a damper area for a size 60" x 8".

Damper air leakage shown is based upon publishing only the most conservative results for the Model GI55 industrial damper for an entire range of damper sizes.

To ensure proper damper operation and air leakage performance for this damper design, the static pressure and blade length limits shown below provide the necessary information and show the relationship between a damper's costs and its applications.

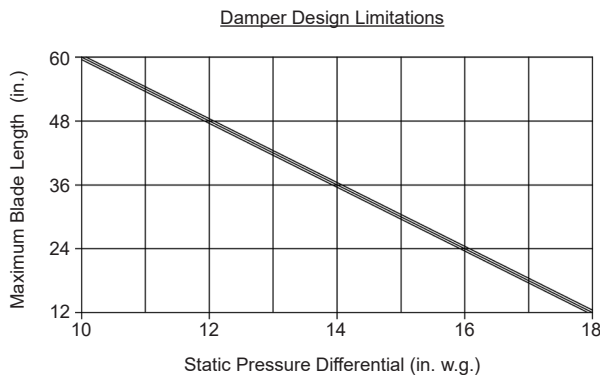

This damper's design at a length of 60" has a maximum allowable blade deflection of $L / 360$ for the static pressure indicated on the chart. At reduced blade lengths, higher static pressure limits can be attained without sacrificing damper operating performance characteristics.

VELOCITY LIMITATIONS

The table below lists the maximum allowable velocity for a given maximum damper size. If application requirements exceed the recommendations listed in the table, please select another model or consult the factory.

Maximum Allowable Velocity

	3000 FPM or less	4000 FPM	5000 FPM
Minimum Size	12"W x 9"H	12"W x 9"H	12"W x 9"H
Maximum Size	60"W x 96"H	60"W x 72"H	60"W x 54"H

PRESSURE DROP DATA

Pressure drop ratings are based on AMCA Standard 500, using test set-up figure 5.3 for a damper installed with duct upstream and downstream. Static pressures are corrected to .075 lb./cu.ft. air density.

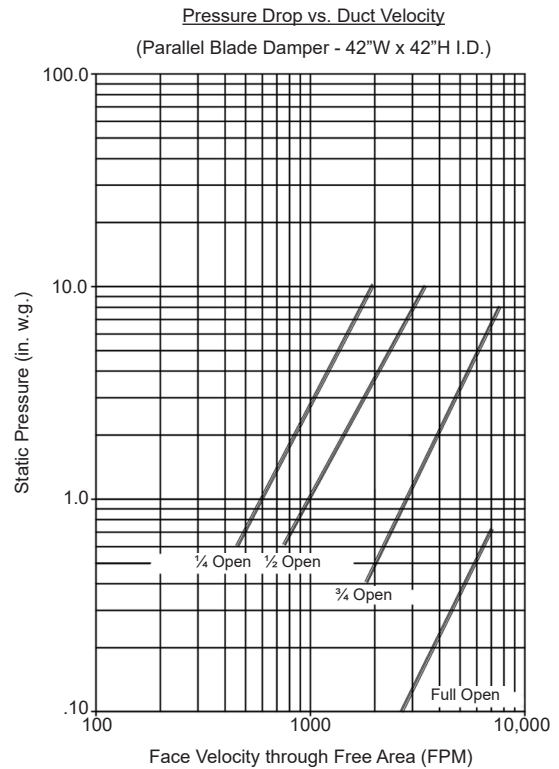
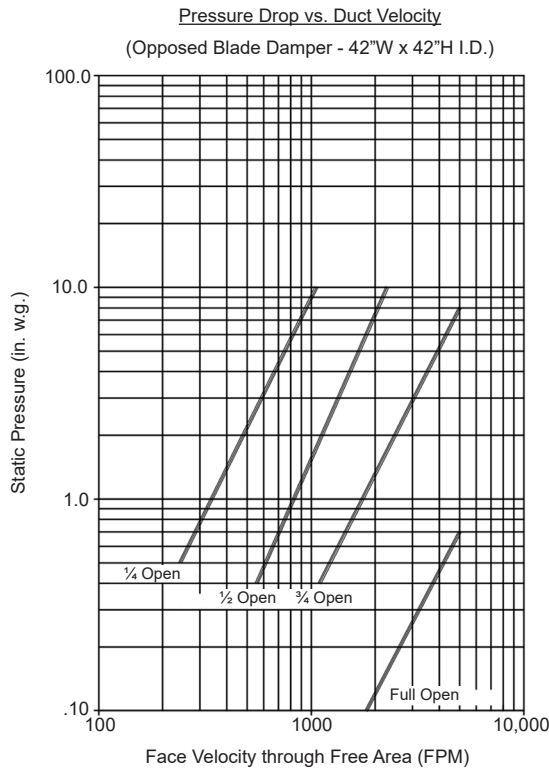

Model GI55

Industrial Damper • 10" Deep • 8" Extruded Aluminum Airfoil Blades • Galvanized Steel Channel Frame • 400° Max Temp

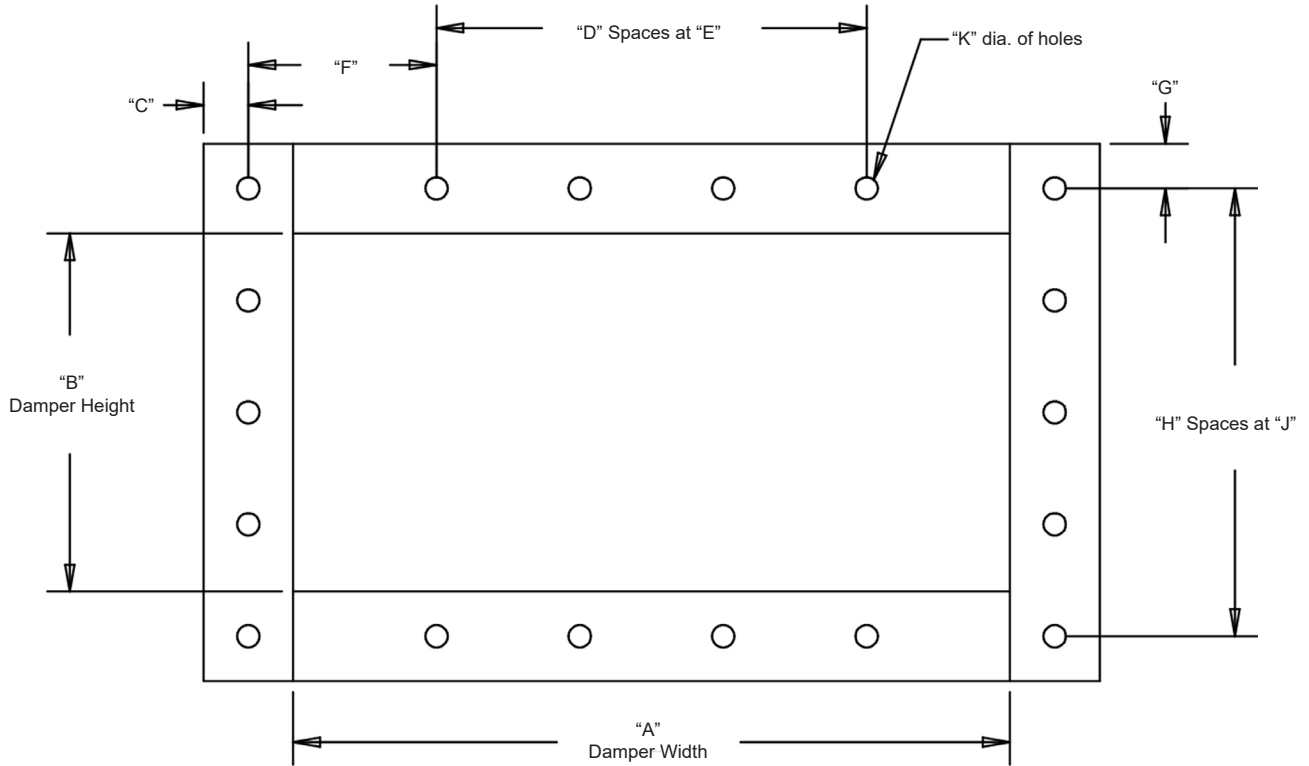

Item #	Qty	"A" Width	"B" Height	"C"	"D"	"E"	"F"	"G"	"H"	"J"	"K"	"M"	Para	Oppo	Hand Quad	Motor Lever Arm		
		Damper Size		Damper Specifics									Blade Position		Actuator	Union Made		
Arch. / Eng.:						EDR:						ECN:				Job:		
Contractor:																		
Project:						Date:						DWN:				DWG:		