

Model 6WK16

Water-Cooled Portable Air Conditioner

Submittal Data



SD-6WK16-4

STANDARD FEATURES

- 16,000 Btu Cooling Capacity
- Spot-Cool / Room-Cool Thermostat Settings
- Internally Insulated with Fiberglass Insulation
- Double Shaft Motor for Two Fans
- Optional Easy Install Condensate Pump Kit with Overflow Protection
- R410A Refrigerant
- 115V/1 Phase
- Directional Nozzles (2)
- Self-Diagnostic System
- Thermostatic Control with Multi-Speed Fan
- Heavy Duty 4 Wheel Casters
- Off-Timer
- 17' Quick Connect Hose Kit
- Automatic Water Regulating Valve
- Rotary Compressor
- Washable Filters

SAFETY DEVICES

- Anti-Freezing Thermistor
- Automatic Restart (Power Interruption)
- Compressor Overload Protection
- Compressor Time Delay Program
- High Pressure Switch
- Full Drain Tank Switch



SPECIFICATIONS

Model Number	6WK16
Cooling Capacity	16,000 Btu/hr
Cooling Test Conditions	95°F
Voltage/Phase/Hz	115/1/60
Amperage	13
Fuse Size	15 Amps*
LCDI Plug Configuration	NEMA 5-15P
Power Cord Length	10'
Refrigerant Type	R410A/21.2
Dimensions	41"H x 20.6"W x 26.4"D
Net Weight	185 Lbs
Shipping Weight	201 Lbs
Condensate Tank Capacity	4.75 Gal

ADDITIONAL SPECIFICATIONS

GPM @ 86°F Entering Water Temp	1.36
Ambient Temperature Range	64-122°F
Setting Temperature (Room Cool/Spot Cool)	64-86°F/32-86°F
Application Area Ft ² (Room Cool Mode)	410
Design Pressure High/Low	465/250 Psig
Indoor Air Flow High/Low	470/400 CFM

*Time delay fuses and circuit breakers are recommended



260 North Elm St.
 Westfield, MA 01085
Phone: 413-564-5520
Fax: 413-564-5815
 www.Koldwave.com

Project: _____ Date: _____

Location: _____

Customer: _____

Engineer: _____

Submitted By: _____

For: Reference Approval Construction

Unit Designation: _____

Schedule Number: _____

Model 6WK16-Submittal Data

CONTROL PANEL

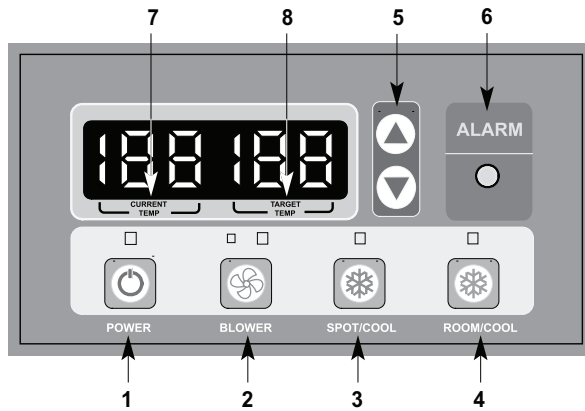

Control Panel Key Buttons:

1. Power
2. Blower
3. Spot/Cool
4. Room/Cool
5. Set Temperature
6. Alarm
7. Current Temperature
8. Target Temperature

COMPONENT PARTS

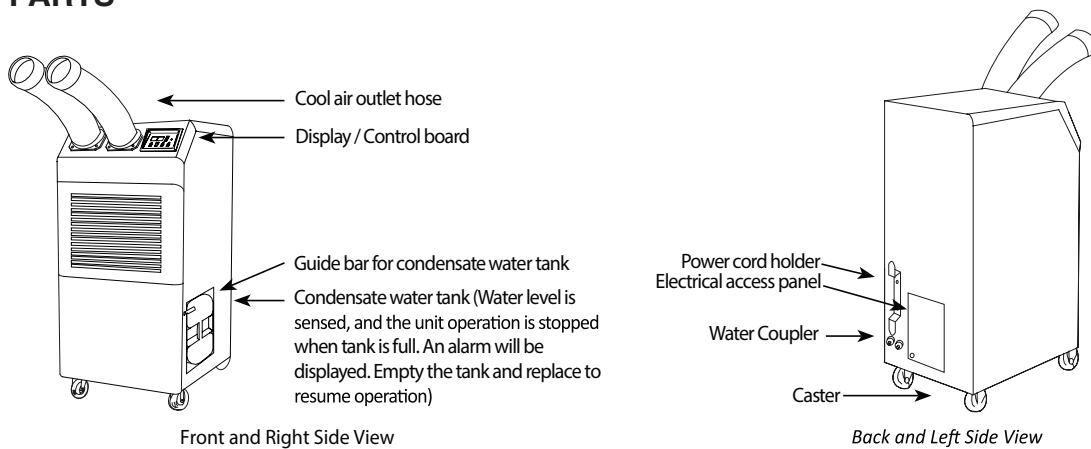

DIMENSIONS (In Inches)

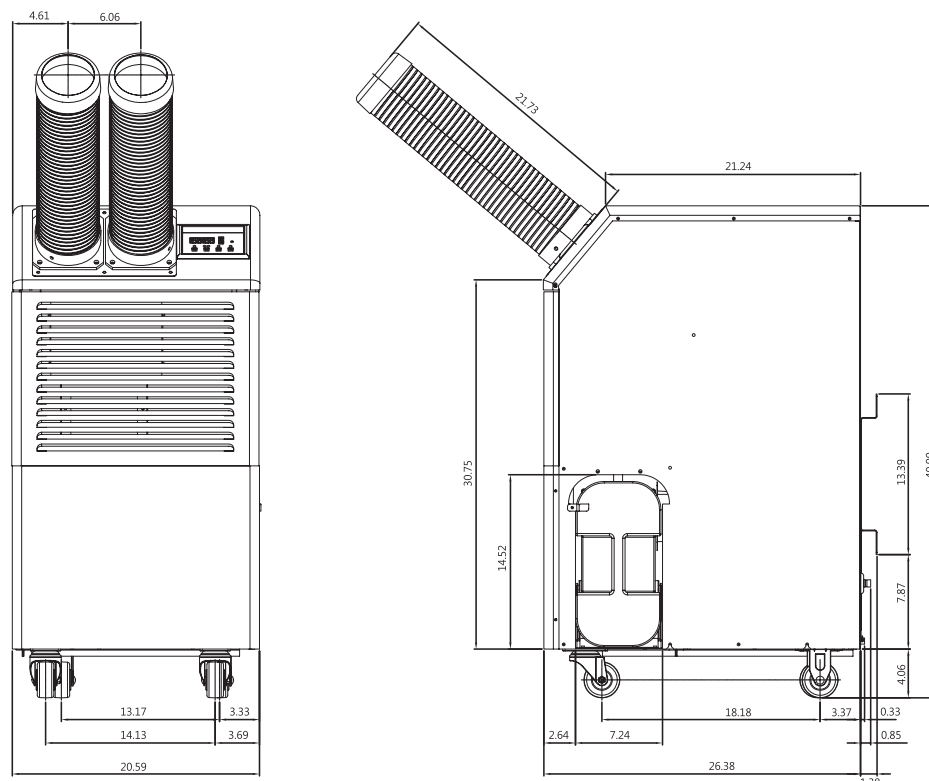

ASSEMBLY

Figure 1

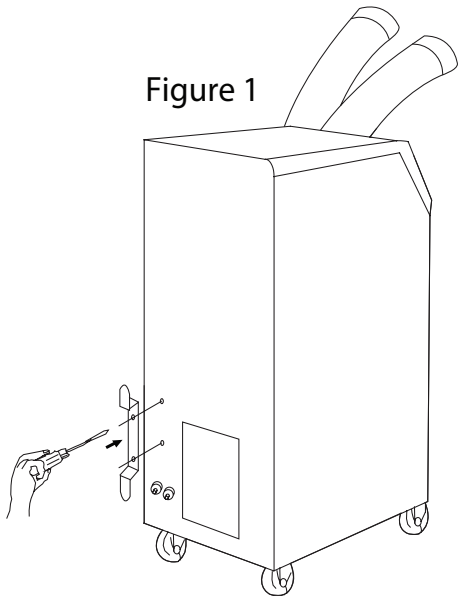

1. Take out the cord holder from the accessory box.
2. Place the cord holder on the left side of unit.
3. Use screws (enclosed inside of accessory box with cord holder) to install the cord holder in the unit as shown in Figure 1.

Figure 2

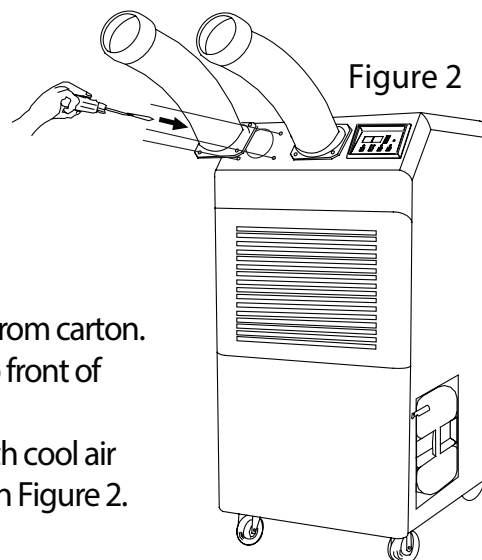

Cool Air Duct Assembly

1. Remove cool air duct assembly 2 pcs from carton.
2. Place the air duct assembly on the top front of unit.
3. Use screws (enclosed inside of box with cool air duct assembly) on the unit as shown in Figure 2.

Model 6WK16-Submittal Data



Accessory Parts

Part Name	Part Number
Condensate pump kit (115V)	SA057-0072
Remote Controller (26 ft with line)	SA076-4006
16 FT Temperature Sensor	SA076-4007
Cool air duct connecting flange (D5", L3")	SA076-4008
Long cool air duct assembly (D5", L40")	SA076-4009
Evaporator plenum	SA076-4005
Filter, Evaporator (Vinyl Chloride)	KWPCFLT-09E