

KN6X+

Category II or Category IV Appliance
(see Installation and Operation Manual for venting information)

CODE OPTIONS

CSD-1	STANDARD
-------	----------

OUTDOOR UNIT

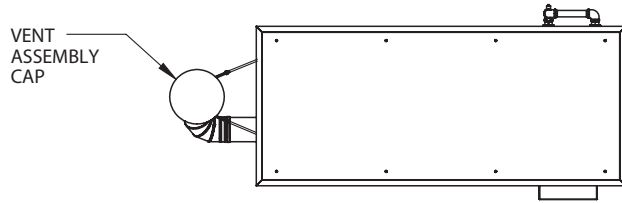

TOP VIEW
ASUB-00062_B

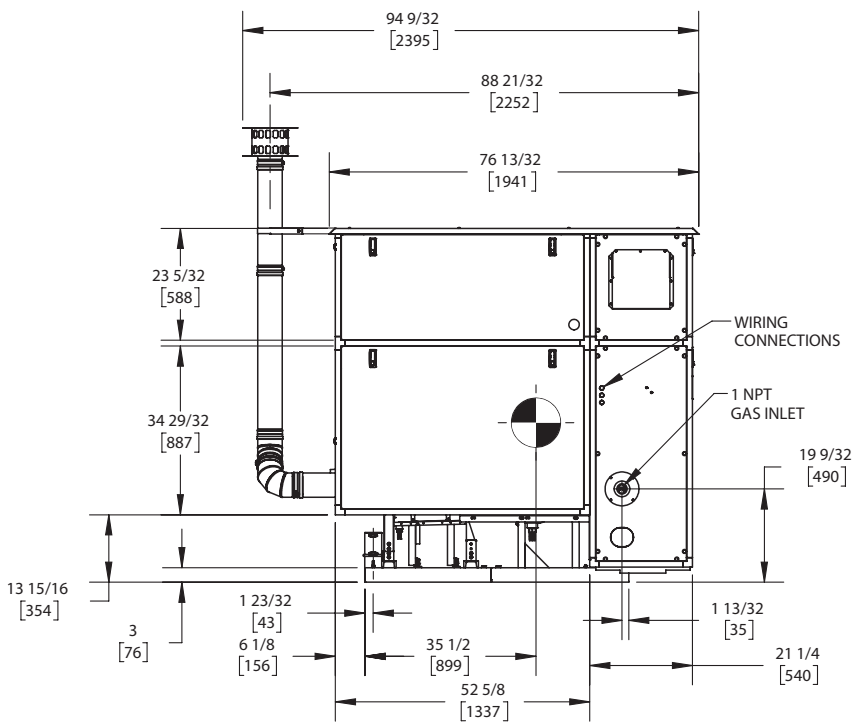

SIDE VIEW
ASUB-00062_B

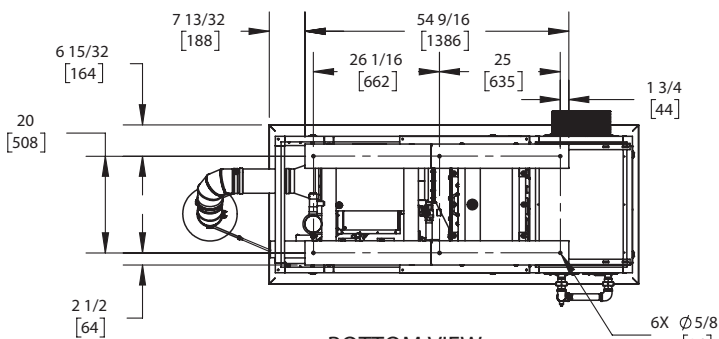

BOTTOM VIEW
ASUB-00062_B

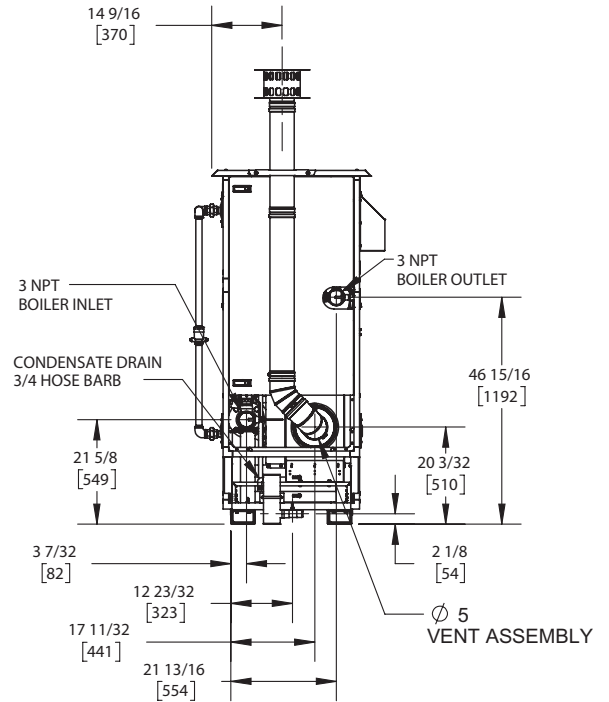

REAR VIEW
ASUB-00062_B

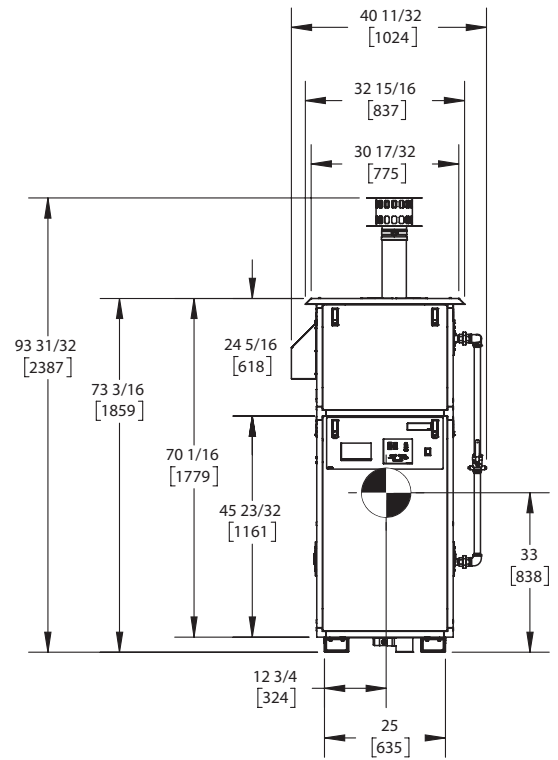

FRONT VIEW
ASUB-00062_B

NOTES:

1. SYMBOL INDICATES CENTER OF GRAVITY.
2. DIMENSIONS ARE NOMINAL AND SUBJECT TO MANUFACTURING VARIATION AND SHOULD NOT BE USED FOR "ROUGHING IN".
3. ALL DIMENSIONS ARE INCHES [mm].



A.G.A. CERTIFIED RATINGS & CAPACITIES

Fuel Type	Natural/LP Gas	Boiler FLA	13.9 A*
Input BTU/hr.	600,000 / 176 KW	Min. Gas Pressure Required	3" W.C.
Output BTU/hr.	573,000 / 168 KW	Max. Gas Pressure Allowed	14" W.C.
Boiler HP	17.1	Water Volume	10.5 gal.
Electrical Requirements	120VAC/ 60 hz/ 1PH	Operating Weight	1485 lbs. / 674 kg.
SCCR Rating	5kA		

BOILER TRIM & CONTROLS

Main Gas Valve	Dungs MBC	Air Switch	Huba
Firing Valve	1" Apollo	Flow Sensor	SIKA
Ignition Control	Honeywell RM7895C	Blocked Flue Switch	Cleveland NS2
Operating Control	HeatNet®	Blower Motor	Ametek
High Limit	Honeywell L4006E	L.W.C.O.	800
Main Ball Valve	1" Apollo	Relief Valve	30, 50, 75 & 100 PSI
Pilot Cock	1/4" Conbraco	Pilot Regulator	Maxitrol RV12LT

A.S.M.E.

ASME Sect IV Fire Side Htg Surface	26.60 Sq. Ft. / 2.47 Sq. M.	Design Data	100 PSI & 250°F
ASME Sect IV Water Side Htg Surface	28.44 Sq. Ft. / 2.64 Sq. M.		
CV. GPM (1PSID)	62		

*Add circulator amps.

TEMPERATURE RISE / PRESSURE DROP (Based on Full Input)

20°F / 11.1°C				40°F / 22.2°C				60°F / 33.3°C				80°F / 44.4°C				100°F / 55.5°C			
Flow Rate		Pressure Drop		Flow Rate		Pressure Drop		Flow Rate		Pressure Drop		Flow Rate		Pressure Drop		Flow Rate		Pressure Drop	
GPM	L/s	Ft	kPa	GPM	L/s	Ft	kPa	GPM	L/s	Ft	kPa	GPM	L/s	Ft	kPa	GPM	L/s	Ft	kPa
57.3	3.62	1.97	5.90	28.7	1.81	.49	1.47	19.1	1.21	.22	.66	14.3	.90	.12	.37	11.5	.72	.08	.24

Flow GPM		Temp. Rise** (°F)		Vent Length (Equiv. Ft.)		Air Inlet Length (Equiv. Ft.)	
Min	Max	Min	Max	Min	Max	Min	Max
11.5	57.3	20	100	6	100	0	100

**Min/Max delta t reflects boiler operation at full input. For applications requiring operation above/below these parameters please consult factory.

REP FIRM	_____
SUBMITTED BY	_____
JOB NAME	_____
ARCHITECT	_____
ENGINEER	_____
CONTRACTOR	_____
DATE	_____

KN6X+

Category II or Category IV Appliance
(see Installation and Operation Manual for venting information)



A Division of Mestek, Inc.
Westfield, MA 01085
(413) 564-5515