

## ML4105, ML4115, ML8105, ML8115 Fast-Acting, Two-Position Actuators

FOR FIRE/SMOKE CONTROL APPLICATIONS



### PRODUCT DATA



### FEATURES

- 30 lb-in. (3.4 N•m) or 50 lb-in. (5.7 N•m) minimum driving torque at 350°F (176°C).
- Integral spring return ensures level of return torque.
- Fifteen-second spring return timing.
- No special cycling required during long-term holding. (See Operation section.)
- No audible noise during holding.
- Patent pending design eliminates need for limit switches to reduce power consumption.
- Models available for 24, 120, and 230 Vac.
- Ninety-five degree angle of rotation.
- Actuator holds rated torque at reduced power level.
- Die-cast aluminum housing.
- Housing design allows flush mounting to damper.
- Integral junction box with three conduit openings eliminates need for separate wiring box.

### APPLICATION

The ML4105, ML4115, ML8105, and ML8115 Fast-Acting, Two-Position Actuators are spring return direct coupled actuators (DCA) with an integral junction box for on/off damper control. The actuator accepts an on/off signal from a single-pole, single-throw (spst) controller. Models are available with clockwise (cw) or counterclockwise (ccw) spring return and are designed to operate reliably in smoke control systems requiring Underwriter's Laboratories Inc. UL555S ratings up to 350°F.

### APPLICABLE LITERATURE

— Motor/Actuator Selection Guide for Damper Applications	63-8419
— Engineering Manual of Automatic Control (also called The Gray Manual)	77-1100
— Direct Coupled Actuator Quick Selection Guide	63-8553
— Damper Torque Calculator	63-8437



## SPECIFICATIONS

**Models:** See Table 1.

**Dimensions:** See Fig. 1.

**Minimum Damper Shaft Length:** 1-3/4 in. (45 mm).

**Device Weight:** 5 lb (2.3 kg).

**Stroke:** 95° ± 3°, mechanically limited.

**Electrical Ratings:** See Table 1.

**Electrical Connections:**

ML4105A,B, ML4115A,B, ML8105, ML8115: Two color coded 16 in. leads; includes ground screw.

ML4105C1008, ML4105D1007: Terminal block and ground screw with option for connecting thermal switch.

ML4105C1016, ML4105D1015, ML4115C,D: 1m appliance cable.

Three 7/8 in. holes for conduit connections (fittings not included).

**Mounting:** 3/8 to 1/2 in. square or round damper shafts.

Actuator can be mounted with shaft in any position. Secure hub to shaft with:

ML4105A,B, ML8105: Four 1/4-28 UNF set screws. Use 1/8 in. Allen wrench to tighten set screws.

ML4105C,D: Four 3 mm set screws. Use 3 mm Allen wrench to tighten set screws.

ML4115, ML8115: Two 1/4-28 UNF set screws. Use 1/8 in. Allen wrench to tighten set screws.

**IMPORTANT**

*Honeywell does not recommend using linkages with these actuators because side-loading of the output hub reduces actuator life.*

**Temperature Ratings:**

Ambient: 0°F to 130°F (-18°C to 55°C).

Shipping and Storage: -40°F to 140°F (-40°C to 60°C).

**IMPORTANT**

*The actuator is designed to meet UL555S standards at 350°F (176°C). The actuator must be tested with the damper to achieve this rating.*

**Humidity Ratings:** 5% to 95% RH noncondensing.

**Noise Rating (Maximum):**

Driving Open: 65 dBA at 1m.

Holding: 20 dBA at 1m (no audible noise).

**Controller Type:**

ML4105A,B, ML4115A,B: Line voltage (120 Vac), two-position, spst (Series 40).

ML4105C,D, ML4115C,D: Line voltage (230 Vac), two-position, spst (Series 40).

ML8105, ML8115: Low voltage (24 Vac), two-position, spst (Series 80).

**Table 1. ML4105, ML4115, ML8105, ML8115 DCA Models.**

Model	Spring Return Direction	Power Consumption		Torque in lb-in. (N•m)	Voltage Input in Vac
		Running	Holding		
ML4105A	ccw	0.20A, 18W	0.11A, 9W	50 (5.7)	120 +10%, -15%, 60 Hz
ML4105B	cw				
ML4105C	ccw	0.12A, 22W	0.08A, 10W	50 (5.7)	230 ±10%, 50/60 Hz
ML4105D	cw				
ML4115A	ccw	0.18A, 18W	0.11A, 9W	30 (3.4)	120 ±10%, 60 Hz
ML4115B	cw				
ML4115C	ccw	0.13A, 18W	0.10A, 11W	30 (3.4)	230 ±10%, 50/60 Hz
ML4115D	cw				
ML8105A	ccw	20 VA	8 VA	50 (5.7)	24 +20%, -10%, 50/60 Hz
ML8105B	cw				
ML8115A	ccw	16 VA	8 VA	30 (3.4)	
ML8115B	cw				

**Torque Rating (at rated voltage):**

Typical Holding: 100 lb-in. (11.3 N•m).

Spring Return:

ML4105, ML8105: 40 lb-in. (4.5 N•m).

ML4115, ML8115: 30 lb-in. (3.4 N•m).

Stall Maximum:

ML4105, ML8105: 240 lb-in. (27 N•m).

ML4115, ML8115: 150 lb-in. (17 N•m).

350°F Driving:

ML4105, ML8105: 50 lb-in. (5.7 N•m).

ML4115, ML8115: 30 lb-in. (3.4 N•m).

## ORDERING INFORMATION

When purchasing replacement and modernization products from your TRADELINE® wholesaler or distributor, refer to the TRADELINE® Catalog or price sheets for complete ordering number.

If you have additional questions, need further information, or would like to comment on our products or services, please write or phone:

1. Your local Honeywell Automation and Control Products Sales Office (check white pages of your phone directory).
2. Honeywell Customer Care  
1885 Douglas Drive North  
Minneapolis, Minnesota 55422-4386

In Canada—Honeywell Limited/Honeywell Limitée, 35 Dynamic Drive, Toronto, Ontario M1V 4Z9.

International Sales and Service Offices in all principal cities of the world. Manufacturing in Australia, Canada, Finland, France, Germany, Japan, Mexico, Netherlands, Spain, Taiwan, United Kingdom, U.S.A.

**Timing (At Rated Torque and Voltage):**

Drive Open:

ML4105, ML8105: 15 sec maximum, 14 sec typical.

ML4115: 25 sec maximum, 18 sec typical.

ML8115: 25 sec maximum, 22 sec typical.

Spring Close: 15 seconds.

**Cycling Requirements:**

Prolonged holding-period (1 year) testing of these actuators has been performed with no spring return failures. The actuator and the internal spring are designed to require no special cycling during long-term holding.

Honeywell recommends following all local, state and national codes for periodic testing of the entire smoke control system. Refer to National Fire Protection Association (NFPA) National Fire Codes®: NFPA90A, NFPA92A and NFPA92B for your application.

NFPA recommends periodic examination of each fire/smoke damper (semi-annually or annually) to ensure proper performance.

**Design Life (at Rated Voltage):** 60,000 full stroke cycles.

**Approvals:** See Table 2.

**Environmental Protection Ratings:** See Table 3.

**Accessories:**

201391 Shaft Adapter for 3/8 in. shafts (not supplied with actuator).

205649 Mounting Bracket (not supplied with actuator).

32003532-005 Dual Auxiliary Switch Package

**Table 2. Approvals.**

	ML4105			ML4115A,B	ML4115C,D ML8105, ML8115
	A,B	C1008, D1007	C1016, D1015		
UL/cUL	X		X	X	X
UL873 Plenum Rating, File No. E4436; Guide No. XAPX.	X	X	X	X	X
CE		X	X		X
C-TICK		X	X		X

**Table 3. Environmental Ratings.**

All Devices	ML4105C1008 ML4105D1007	ML4105C1016 ML4105D1015 ML4115C,D
NEMA1	IP40	IP54

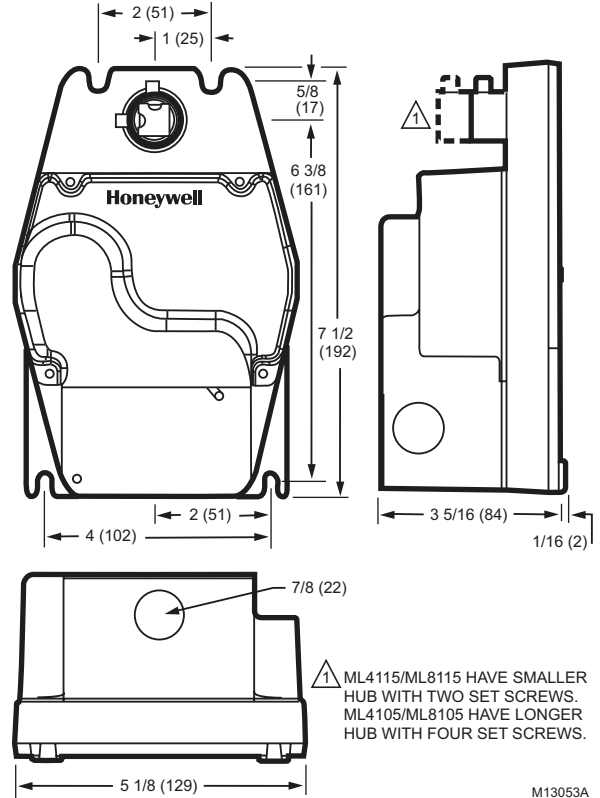

**Fig. 1. ML4105/ML4115/ML8105/ML8115 dimensional drawing in in. (mm).**

## INSTALLATION

### When Installing this Product...

1. Read these instructions carefully. Failure to follow them could damage the product or cause a hazardous condition.
2. Check the ratings given in the instructions and on the product to make sure the product is suitable for your application.
3. Installer must be a trained, experienced service technician.
4. After installation is complete, check out product operation as provided in these instructions.

#### IMPORTANT

All wiring must agree with applicable codes, ordinances and regulations.

### **!** WARNING

**Electrical Power Hazard.**  
Line voltage can cause death or serious injury and short equipment circuitry.  
Disconnect power supply before installation.

### **!** CAUTION

**Electrical Shock or Equipment Damage Hazard.**  
Low voltage can shock individuals or short equipment circuitry.  
Disconnect power supply before installation.

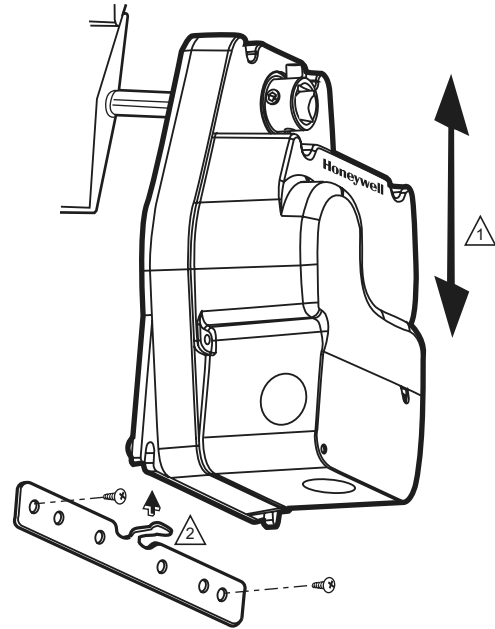

**!** ENSURE THAT MOUNTING ASSEMBLY PREVENTS ACTUATOR ROTATION AND ALLOWS ACTUATOR TO FLOAT ALONG INDICATED AXIS. WHEN TOO TIGHT, THE RESULTING BINDING CAN DAMAGE THE ACTUATOR OR REDUCE TORQUE OUTPUT.

**!** ACCESSORY MOUNTING BRACKET IS NOT SUPPLIED WITH THE ACTUATOR. M13054A

Fig. 2. Mounting actuator to damper housing.

### Location and Mounting

The ML4105, ML4115, ML8105 and ML8115 DCA are designed to open a damper by driving the damper shaft in either clockwise or counterclockwise direction. The actuator housing has two slots on the bottom that, with a 205649 Mounting Bracket, secure it flush to a damper box (see Fig. 2). When mounted correctly, these slots allow the actuator to *float* without rotating relative to the damper shaft.

### **!** CAUTION

**Equipment Damage Hazard.**  
Tightly securing actuator to damper housing can damage actuator.  
Mount actuator to allow it to float along its vertical axis.

NOTE: ML4105, ML4115, ML8105, and ML8115 Actuators are shipped in the fully closed position.

### Preparation

Before mounting the actuator onto the damper shaft, determine the damper shaft size (3/8 in. to 1/2 in. [10 mm to 13 mm]).

If damper shaft is 3/8 in. (10 mm) round or square, use part number 201391 Shaft Adapter (*not supplied with actuator*). Place adapter opposite set screws (see Fig. 3).

NOTE: The damper shaft adapter centers a 3/8 in. (10 mm) damper shaft in the hub. Failure to use adapter can cause mounting screws to loosen. A 1/2 in. (13 mm) damper shaft does not require an adapter.

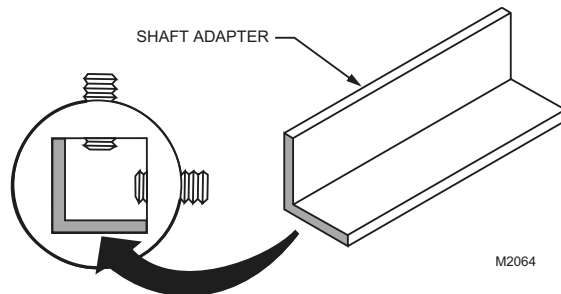

Fig. 3. Using damper shaft adapter for 3/8 in. (10 mm) damper shafts.

## Installation



### CAUTION

**Device Malfunction Hazard.**  
Improper set screw tightening causes device malfunction.

Tighten set screws with proper torque to prevent damper shaft slippage.



### CAUTION

**Actuator Damage Hazard.**  
Using actuator as shaft bearing causes device damage.

Use actuator only to supply rotational torque. Avoid any side loads to actuator output coupling bearings.

To install actuator, proceed as follows:

1. Place actuator over damper shaft; and hold mounting bracket in place. See Fig. 2.
2. Mark screw holes on damper housing.
3. Remove actuator and mounting bracket.
4. Drill or center-punch holes for mounting screws (or use no.10 self-tapping sheet metal screws).
5. Turn damper blades to desired normal (closed) position.
6. Place actuator and mounting bracket back into position and secure bracket to damper box with sheet metal screws.
7. Tighten set screws securely into damper shaft using minimum 30 lb-in., maximum 60 lb-in. torque. Use 1/8 in. or 3 mm Allen wrench (see Specifications for details) to tighten set screws.

## Wiring

See Fig. 4 through 8 for typical wiring diagrams.



### WARNING

**Electrical Power Hazard.**  
Line voltage can cause death or serious injury and short equipment circuitry.

Disconnect power supply before installation.



### CAUTION

**Electrical Shock or Equipment Damage Hazard.**  
Low voltage can shock individuals or short equipment circuitry.

Disconnect power supply before installation.

### IMPORTANT

1. All wiring must comply with local electrical codes, ordinances and regulations.
2. Voltage and frequency of transformer used with ML8105 and ML8115 must correspond with the characteristics of power supply and actuator.
3. Use wires rated for at least 75°C (167°F).

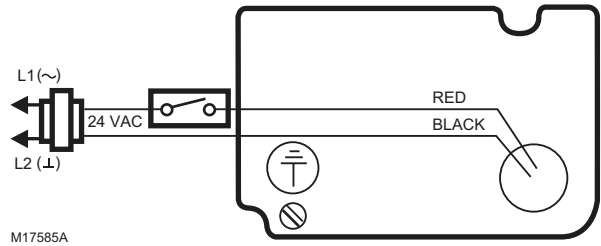

M17585A

Fig. 4. Typical 24 Vac wiring.

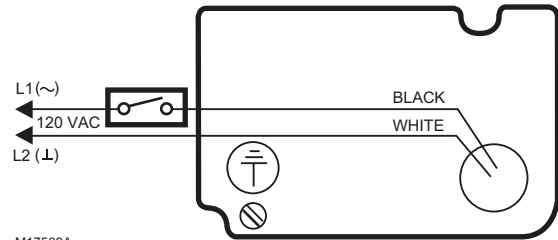

M17589A

Fig. 5. Typical 120 Vac wiring.

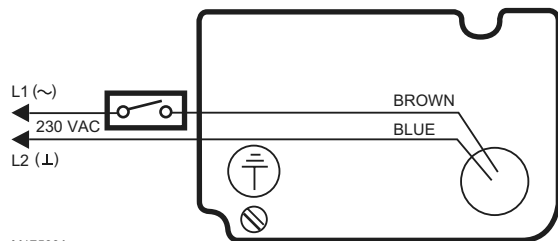

M17588A

Fig. 6. Typical 230 Vac wiring.

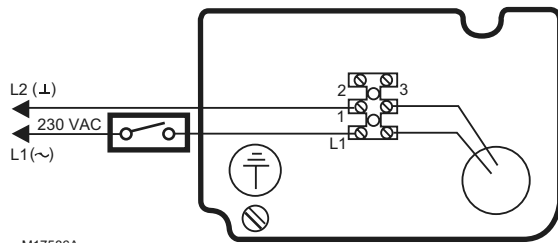

M17586A

Fig. 7. 230 Vac terminal-strip wiring.

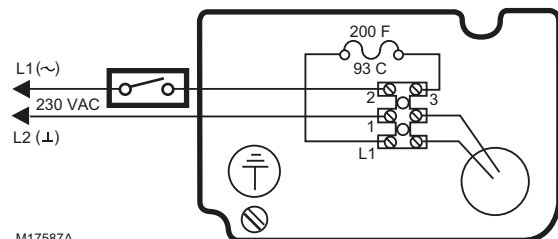

M17587A

Fig. 8. 230 Vac terminal-strip wiring with a thermal fuse.

NOTE: Terminal strip included with ML4105C1008 and ML4105D1007.

## OPERATION

The ML4105, ML4115, ML8105, and ML8115 DCA are designed for use in Smoke Control Systems. If power fails, the actuator spring returns to the 0° position. The actuator mounts flush with the damper box. The actuator drives from 0° to 95° and spring returns back to 0°.

### **IMPORTANT**

*For actuators with a product date code before 0527, a power break of less than two seconds can cause the actuator to spring-return 5 degrees or less and remain in place until a power break of longer duration. For actuators with a product date code of 0527 or after, a power break of any duration will cause the actuator to spring-return and be able to drive immediately when power is reapplied.*

The actuators are operated by an spst two-position controller. When using an spst two-position controller, the actuator drives to the damper fully open position when controller contact makes and spring returns to the damper fully closed position when controller contact breaks. The actuator drops to holding power level on detection of stall, independent of hub position.

## Cycling

The actuator and the internal spring are designed so that no special cycling during long-term holding is required. Honeywell recommends following all local, state, and national codes for periodic testing of the entire smoke control system. Refer to National Fire Protection Association (NFPA) National Fire Codes®: NFPA90A, NFPA92A, and NFPA92B for your application.

**NOTE:** The actuator is designed to operate for 30 minutes during a one-time excursion to 350°F (176°C).

## CHECKOUT

### **ML4105A,B and ML4115A,B (120 Vac model)**

1. Check damper position.
2. Connect 120 Vac to the black and white leadwires to drive the damper to the open position. The actuator should drive the damper.
3. If the actuator does not run, remove power for at least two seconds.
4. If the actuator spring returns, allow it to close entirely, then return to step 2.
5. If the actuator does not spring return, verify that the actuator is properly installed. See Installation section.
6. If the actuator is correctly installed but neither runs nor spring returns, replace the actuator.

### **ML4105C,D and ML4115C,D (230 Vac model)**

1. Check damper position.
2. Connect 230 Vac to the blue and brown leadwires to drive the damper to the open position. The actuator should drive the damper.
3. If the actuator does not run, remove power for at least two seconds.
4. If the actuator spring returns, allow it to close entirely, then return to step 2.
5. If the actuator does not spring return, verify that the actuator is properly installed. See Installation section.
6. If the actuator is correctly installed but neither runs nor spring returns, replace the actuator.

### **ML8105 and ML8115 (24 Vac model)**

1. Check damper position.
2. Connect 24 Vac to the red and black leadwires to drive the damper to the open position. The actuator should drive the damper.
3. If the actuator does not run, remove power for at least two seconds.
4. If the actuator spring returns, allow it to close entirely, then return to step 2.
5. If the actuator does not spring return, verify that the actuator is properly installed. See Installation section.
6. If the actuator is correctly installed but neither runs nor spring returns, replace the actuator.

- D Montageanweisung
- F Instructions d'Installation
- I Istruzioni per l'Installazione
- NL Installatievoorschrift
- DK Installasjonsinstruks
- N Installationsinstruktioner
- SF Asennusohje
- S Installations Instruktioner
- E Instrucciones de montaje

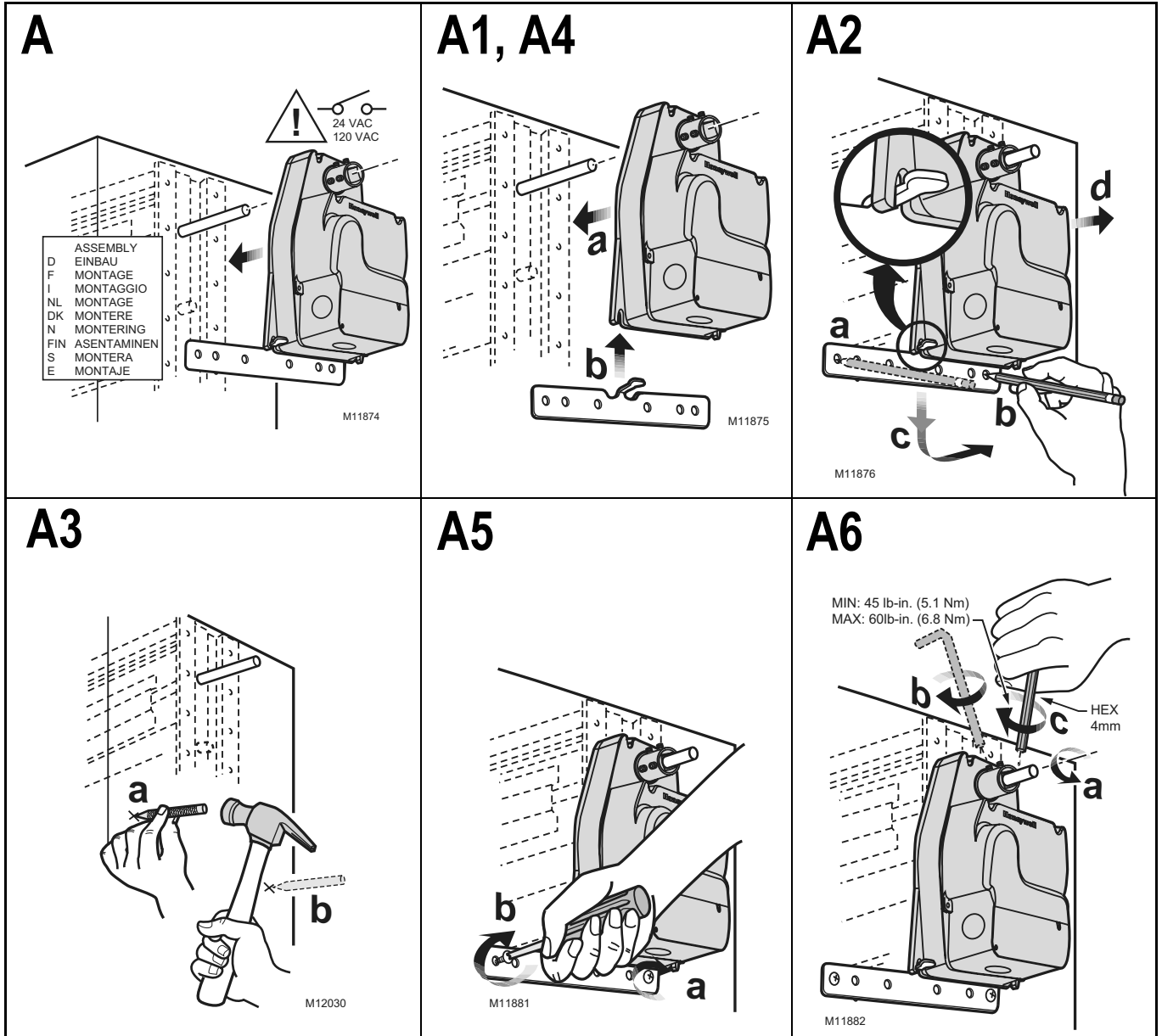

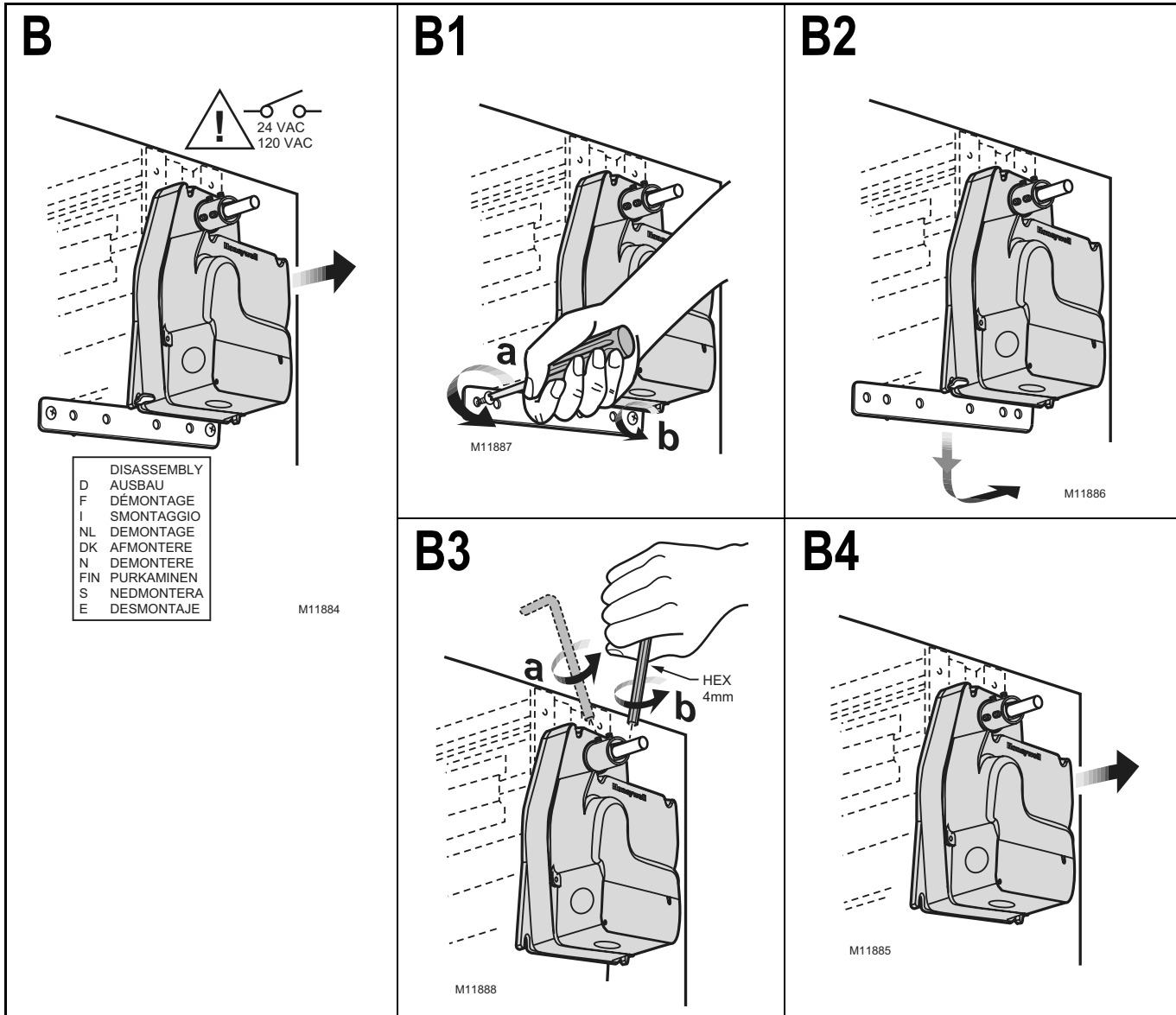

National Fire Codes<sup>®</sup> is a registered trademark of the National Fire Protection Association (NFPA).

**Automation and Control Solutions**

Honeywell International Inc.  
1985 Douglas Drive North  
Golden Valley, MN 55422  
customer.honeywell.com

Honeywell Limited-Honeywell Limitée  
35 Dynamic Drive  
Toronto, Ontario M1V 4Z9

® U.S. Registered Trademark  
© 2007 Honeywell International Inc.  
63-2540—11 C.H. Rev. 04-07

Printed in U.S.A. on recycled paper containing at least 10% post-consumer paper fibers.

**Honeywell**