



RBU Series
Unit is shown rotated at a 45° angle.



RBD Series

INFRARED RADIANT HEATERS

High and Low Intensity



HIGH INTENSITY INFRARED HEATERS

RBD Series Ceramic Heaters

- Special Honeycomb Tile Design for Increased Radiant Output
- Inputs from 30,000 to 160,000 Btu/hr
- Suitable for Angle Mount up to 35°
- All Heaters are Equipped with 100% Gas Shut-off Safety Control
- 24 Volt Direct Spark Ignition System
- Natural or Propane Gas
- Indirect Vented Operation

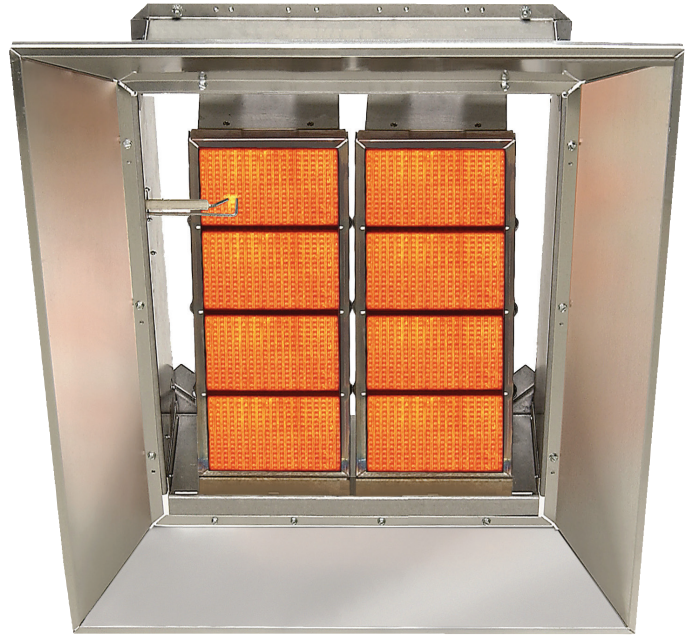

BURNER AND BODY CONSTRUCTION

- Modular Burner Construction and Venturi
- Heavy Gauge Aluminized Steel Burner Head and Venturi
- Stainless Steel Tile Retainer Assembly
- Corrosion Resistant Aluminized Steel Body Construction

EMITTER SURFACE

- Special Honeycomb Tile Design for Increased Radiant Output
- Up to 1800°F Surface Temperature
- 5-Year Limited Warranty on Emitter Tiles
- Optional Incoloy 800 Reverberatory Screen for Secondary Radiating Surface and Additional Safety



REFLECTOR

- Highly Efficient Aluminum Reflectors
- Double-formed Edges for Rigidity
- Optional Parabolic Extension for Higher Mounting Heights

OTHER

- Simple Chain Mounting
- 1/2" NPT Female Gas Pipe Connection
- 120 Volt Electrical Supply (0.4 Amp Draw)
- 120/24 Volt Transformer Included
- Heaters can be Shipped by UPS

PERFORMANCE DATA

MODEL	GAS TYPE	INPUT BTU/HR	NO. OF BURNERS	BURNER PRESSURE (Water Column)	SUPPLY PRESSURE (Water Column)		MINIMUM MOUNTING HEIGHT
					MIN	MAX	
RBD30	NAT	30,000	1	6"	7"	14"	11'
RBD33	LP	33,000	1	10"	11"	14"	11'
RBD35	NAT	35,000	1	6"	7"	14"	12'
RBD40	NAT	40,000	1	6"	7"	14"	12'
RBD60	NAT	60,000	2	6"	7"	14"	13'
RBD66	LP	66,000	2	10"	11"	14"	13'
RBD70	NAT	70,000	2	6"	7"	14"	13'
RBD80	NAT	80,000	2	6"	7"	14"	14'
RBD100	NAT	100,000	3	6"	7"	14"	15'
RBD100	LP	99,000	3	10"	11"	14"	15'
RBD120	NAT	120,000	3	6"	7"	14"	16'
RBD132	LP	132,000	4	10"	11"	14"	17'
RBD140	NAT	140,000	4	6"	7"	14"	17'
RBD160	NAT	160,000	4	6"	7"	14"	18'

RBD MOUNTING HEIGHTS, CLEARANCES & DIMENSIONS

Minimum Recommended Mounting Heights (Feet)

MODEL	HORIZONTAL		35° ANGLE	
	STANDARD REFLECTOR	W/ PARABOLIC EXTENSION	STANDARD REFLECTOR	W/ PARABOLIC EXTENSION
RBD30 RBD33	11	12	10	12
RBD35 RBD40	12	13	11	13
RBD60 RBD66 RBD70	13	15	12	14
RBD80	14	16	13	15
RBD100	15	17	14	16
RBD120	16	18	15	17
RBD132 RBD140	17	19	16	18
RBD160	18	20	17	19

Minimum Clearances To Combustibles

MODEL	HORIZONTAL		35° ANGLE						ANGLE MTG. (DEGREE)	
	SIDES	CEILING	BELOW		BELOW		FRONT			REAR (35°)
			STANDARD REFLECTOR	W/ PARABOLIC EXTENSION	STANDARD REFLECTOR	W/ PARABOLIC EXTENSION	STANDARD REFLECTOR	W/ PARABOLIC EXTENSION		
RBD30 RBD35 RBD33 RBD40	30"	36"	72"	100"	72"	100"	36"	50"	30"	0 min/35 max
RBD60 RBD70 RBD66 RBD80	48"	48"	98"	137"	98"	137"	48"	68"	36"	0 min/35 max
RBD100 RBD120	48"	64"	128"	180"	128"	180"	60"	84"	48"	0 min/35 max
RBD132 RBD160 RBD140	60"	64"	136"	190"	136"	190"	64"	90"	48"	10 min/35 max

Observe all required clearances as shown. Clearances are measured from the reflector edge.

RBD SERIES ARCHITECTURAL/ENGINEERING SHORT FORM SPECIFICATIONS

Gas-Fired infrared space heaters shall be furnished and installed in accordance with governing codes and as shown per building drawing(s) as described below: Heaters shall be RBD series ceramic heaters, model number(s) RBD _____, _____ Btu/hr, as manufactured. Heaters shall be equipped with a 24V direct spark ignition system with 100% gas shutoff.

Heaters shall be made of aluminized steel body construction and shall consist of multiple burner heads. Heaters shall utilize special honeycomb tile design for increased radiant output. As an option, heaters can utilize an Incoloy 800 reverberatory screen that will increase the overall emissivity of the radiant surface with a black body radiation effect and could serve as a protective screen in the unlikely event that the ceramic tile assembly is broken by an outside force. The tile temperatures can vary from 1650°F-1800°F and tiles shall withstand thermal shock when water quenched.

Heaters shall operate satisfactorily in any position from horizontal to thirty five degrees from horizontal. Heaters shall be Design Certified by C.S.A. to American National Standard Z83.19 /CSA Standard 2.35. The manufacturer shall provide a written limited warranty of five (5) years covering the emitter tiles and a limited warranty of one (1) year for all components utilized in the heater's control assembly.

END VIEW DIMENSIONS

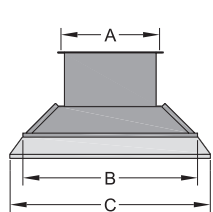

MODEL	A	B	C
RBD30 RBD33 RBD35 RBD40	9"	15 3/4"	17 3/4"
RBD60 RBD66 RBD70 RBD80	14 7/8"	21 5/8"	23 5/8"
RBD100 RBD120	20 3/4"	27 1/2"	23 1/2"
RBD132 RBD140 RBD160	26 5/8"	33 3/8"	35 3/8"

END VIEW DIMENSIONS

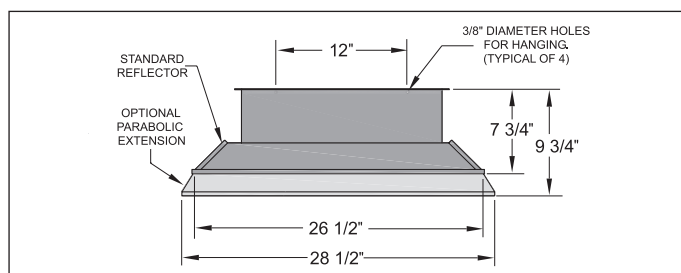

Mounting Height

Ceramic heaters may be mounted at various heights and angles, according to the results desired. Please consult your representative for your radiant heating requirements. Observe all required clearances to combustibles shown above.

Combustion Air and Ventilation

Combustion air and venting requirements for all gas-fired heating equipment must be provided per National Fuel Gas Code NFPA54, CAN B149 or the authority having jurisdiction over the installation. Indirect vented ceramic heaters require a minimum ventilation flow of 4 CFM per 1000 Btu per hour of total installed heater capacity on natural gas by either gravity or power ventilation (4.18 CFM per 1000 Btu per hour on propane). For more ventilation information, consult the ASHRAE handbooks, local codes, and the Application Manual. Building exhaust openings for indirect vented applications always must be located above the level of the heaters and inlet air openings always must be located below the level of the heaters.

For Your Safety

OPERATE INFRARED HEATERS WITH PROPER CARE AND OBSERVE ALL SAFETY PRECAUTIONS. Carefully follow the printed installation, operation, and cleaning instructions furnished with these heaters. Follow the instructions on the nameplate of each heater and use in accordance with National, State, and Local Codes or the authority having jurisdiction. Adequate ventilation always must be provided in accordance with the codes.

LOW INTENSITY INFRARED HEATERS

RBS/RBU Series Tube Infrared Heaters

RBU SERIES

Provides more uniform radiant energy distribution
Ideal for high heat loss areas, spot or area heating.
(Shown with optional U-bend reflector.)

Unit is shown rotated at a 45° angle.



RBS SERIES

Available in multiple configurations (straight, L, Z and expanded U-configuration) with lengths up to 70 feet. Ideal for complete building heating.

Unit is shown rotated at a 45° angle.



Push Through System (Positive Pressure)

- Products of combustion are pushed through the combustion chamber
- Tube Integrity Safety System
- No draft hoods, totally enclosed combustion chamber
- Blower motor totally enclosed in the burner box. Ideal for applications where minimal noise (less than 50 dB) is desired
- Heavy duty permanently lubricated, ball bearing blower motor for maintenance-free operation

Burner System

- Heavy-duty cast iron burner
- 10-year limited warranty on burner
- Inside or outside air for combustion
- Up to 40 ft. outside combustion air duct capability
- Standard 4" combustion air collar
- Reliable direct spark ignition system and 100% gas shut-off safety control
- Pre-purge and post-purge function
- Slow step opening redundant combination gas valve for quiet ignition and added safety
- Diaphragm air switch for proof of venting
- Diagnostic monitoring light system & burner inspection sight glass
- 36" stainless steel, flexible gas connector included with burner
- Line voltage or external 24V thermostat connection

Reflector System

- Highly efficient aluminum reflectors with reflectivity rating of 97.5%
- Standard end reflectors
- Optional corner, side and U-bend reflectors
- Optional decorative grille
- Individual reflectors can be rotated up to 45° to direct heat where needed
- Easy-to-use mounting brackets and wire hangers

Radiant Emitter Tube System

- 4" O.D. heavy-duty heat treated aluminized steel or alumitherm steel combustion chamber (10 ft.) and heavy duty hot-rolled steel radiant emitter tubes
- Optional heat treated aluminized steel (ALC) radiant emitter tubes
- 5-year limited warranty on the emitter tubes
- Suitable for horizontal or angle mounting up to 45°
- Optional 90° elbows
- Up to 40 ft. sidewall vent capability
- Vented or indirect vented operation

PERFORMANCE DATA

MODELS	SINGLE STAGE BTU/HR INPUT	TWO STAGE		TOTAL EMITTER TUBE LENGTH*				
		BTU/HR HIGH INPUT	BTU/HR LOW INPUT	10 FT**	20 FT	30 FT	40 FT	50 FT
RBS/U 40	40,000	40,000	25,000	•	•			
RBS/U 50	50,000	50,000	30,000		•	•	•	
RBS/U 75	75,000	75,000	50,000		•	•	•	
RBS/U 100	100,000	100,000	65,000			•	•	•

MODELS	SINGLE STAGE BTU/HR INPUT	TWO STAGE		TOTAL EMITTER TUBE LENGTH*				
		BTU/HR HIGH INPUT	BTU/HR LOW INPUT	30 FT	40 FT	50 FT	60 FT	70 FT
RBS/U 125	125,000	125,000	80,000	•	•	•	•	
RBS/U 150	150,000	150,000	100,000		•	•	•	
RBS/U 175	175,000	175,000	110,000			•	•	•
RBS/U 200	200,000	200,000	125,000			•	•	•

* Indicate model number based on Btu/hr input (e.g., 100,000 Btu/hr), total emitter length, (e.g., 40 ft.) and gas type (e.g., natural gas single stage input). The unit selection for a straight tube would be RBS100-40-N1 and for a U-tube would be RBUS100-40-N1.

** Available only on RBS models.

GAS CONTROL OPTIONS

CONTROL SUFFIX	TYPE OF GAS	DESCRIPTION
N1 / L1	NATURAL / PROPANE	SINGLE STAGE GAS VALVE - SINGLE STAGE INPUT
N2 / L2	NATURAL / PROPANE	TWO STAGE GAS VALVE - MODULATING INPUT - HIGH/LOW FIRE



ALC Option: All heat treated aluminized steel (ALC) radiant emitter tubes for ALC option the model number would be RBS100-40-ALC-N1.

Note: for carwashes, dairy barns, greenhouses, swimming pools, waste water treatment plants, and other high humidity/corrosive environments, the ALC option with all heat treated aluminized tubes is recommended.

INSTALLATION CONNECTION REQUIREMENTS

GAS TYPE	BURNER PRESSURE	SUPPLY PRESSURE		VOLTAGE	AMPS	IGNITION TYPE	FLUE CONNECTION	OUTSIDE COMBUSTION AIR CONNECTION
		MIN	MAX					
NATURAL	3.5" W.C.	5" W.C.*	14" W.C.	120 VAC 60 HZ	1.8	DIRECT SPARK	4" ROUND	4" ROUND
PROPANE	10" W.C.	11" W.C.**	14" W.C.					

Note: For installations higher than 2000 ft above sea level, please consult the factory regarding recommended derating of heaters.

* 7" W.C. for RBS/U 150-200

** 12" for RBS/U 200

TUBE INTEGRITY SAFETY SYSTEM

In the unlikely event of a tube failure, Tube Integrity Safety System has been designed to automatically shut-off the heater, providing greater safety and peace of mind.

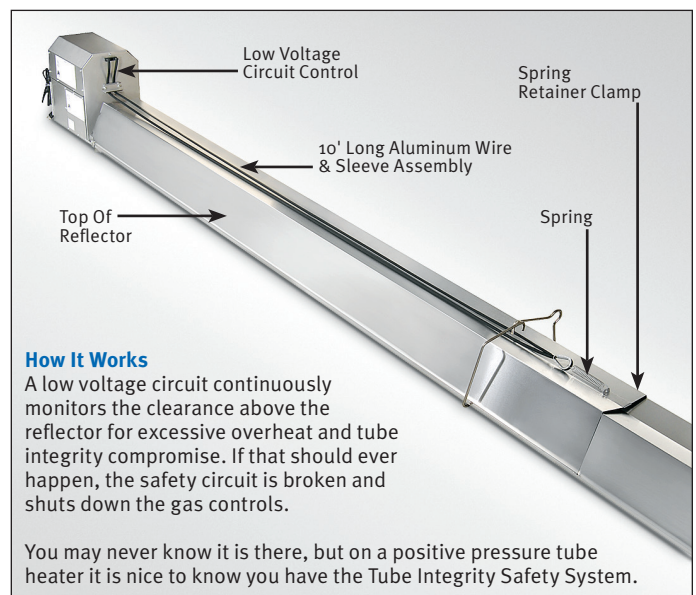

LOW INTENSITY INFRARED HEATERS

RBS/U MOUNTING HEIGHTS, CLEARANCES & DIMENSIONS

Minimum Recommended Mounting Heights

MODEL	HEIGHT AT HORIZONTAL	HEIGHT AT 45° ANGLE
RBS/U 40	10 Ft.	9 Ft.
RBS/U 50	11 Ft.	10 Ft.
RBS/U 75	12 Ft.	12 Ft.
RBS/U 100	14 Ft.	13 Ft.

MODEL	HEIGHT AT HORIZONTAL	HEIGHT AT 45° ANGLE
RBS/U 125	14 Ft.	13 Ft.
RBS/U 150	15 Ft.	14 Ft.
RBS/U 175	16 Ft.	15 Ft.
RBS/U 200	18 Ft.	17 Ft.

This chart is intended as a guide only, as heaters may be mounted at various heights and angles. Since straight tube heaters are always hotter at the burner end than at the exhaust end, always observe the minimum recommended mounting heights shown above and mount heaters as high as possible. Use RBU series for spot heating. Please consult your local Representative for a detailed analysis of your particular infrared heating requirements.

Minimum Clearances To Combustibles

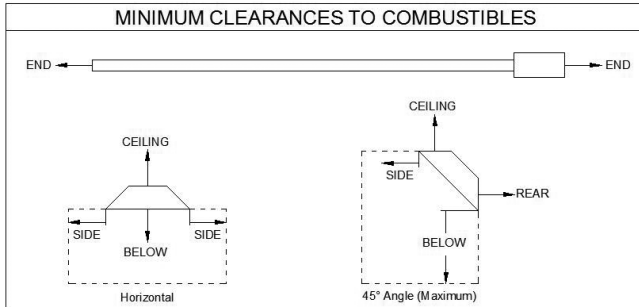

MODEL	SIDE	CEILING*	BELOW	END	45° FRONT	45° REAR
RBS/U 40	22"	6"	52"	15"	40"	12"
RBS/U 50	22"	6"	56"	15"	48"	12"
RBS/U 75	22"	6"	60"	15"	52"	12"
RBS/U 100	28"	6"	70"***	15"	58"	12"
RBS/U 125	28"	6"	76"***	20"	66"	12"
RBS/U 150	34"	6"	81"***	20"	70"	12"
RBS/U 175	38"	6"	86"***	20"	75"	12"
RBS/U 200	42"	6"	93"***	20"	80"	12"

* When used indirect vented, clearances to ceiling must be: 12" for RBS/U (50-75), and 18" on RBS/U (100-200). If optional corner or U-bend reflectors are not used, the clearance must be 18".

** Minimum clearance below reduces by 50% once you are 25 ft. downstream from the burner box.

Note: Consult factory if reduced clearances are required.

RBS DIMENSIONS

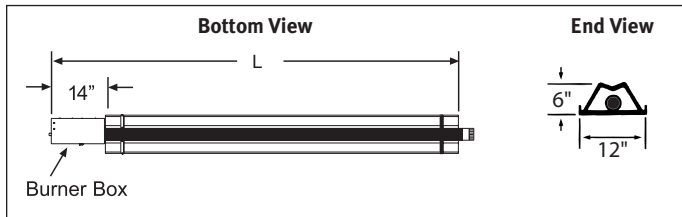

MODEL	TOTAL TUBE LENGTH	OVERALL DIMENSION "L"
RBS 40	10'	11' 2"
RBS (40, 50, 75)	20'	21' 2"
RBS (50, 75, 100, 125)	30'	31' 2"
RBS (50, 75, 100, 125, 150)	40'	41' 2"
RBS (100, 125, 150, 175, 200)	50'	51' 2"
RBS (125, 150, 175, 200)	60'	61' 2"
RBS (175, 200)	70'	71' 2"

RBU DIMENSIONS

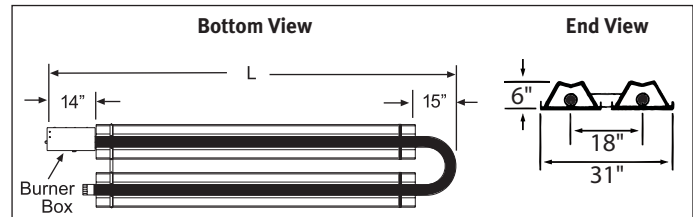

MODEL	TOTAL TUBE LENGTH	OVERALL DIMENSION "L"
RBU (40, 50, 75)	20'	12' 5"
RBU (50, 75, 100, 125)	30'	17' 5"
RBU (50, 75, 100, 125, 150)	40'	22' 5"
RBU (100, 125, 150, 175, 200)	50'	27' 5"
RBU (125, 150, 175, 200)	60'	32' 5"
RBU (175, 200)	70'	37' 5"

Combustion Air and Ventilation

Combustion air and venting requirements for all gas-fired heating equipment must be provided per the National Fuel Gas Code NFPA54 or the authority having jurisdiction over the installation. In contaminated atmospheres or high humidity areas, optional outside air for combustion can be supplied. Heaters can be common vented, vented, or indirect vented. Refer to the Installation and Operation Instructions for further information. A vented installation must be vented to the outside of the building with a flue pipe. An Indirect vented installation requires a minimum ventilation flow of 4 CFM per 1000 Btu/hr of total installed heater capacity on natural gas by either gravity or power ventilation (4.18 CFM per 1000 Btu/hr for propane). For indirect vented applications, building exhaust openings must be located above the level of the heaters and inlet air openings must be located below the level of the heaters.

For Your Safety

OPERATE GAS INFRARED HEATERS WITH PROPER CARE AND OBSERVE ALL SAFETY PRECAUTIONS. Installation and service must be performed by a licensed contractor. The installation must conform to Manufacturer's Installation and Operating Instructions or local codes. In the absence of local codes, the installation must conform to the National Fuel Gas Code ANSI Z223.1 (latest edition, also known as NFPA54) or CAN / CSA-B149 installation codes (latest edition).

Layout Sketch

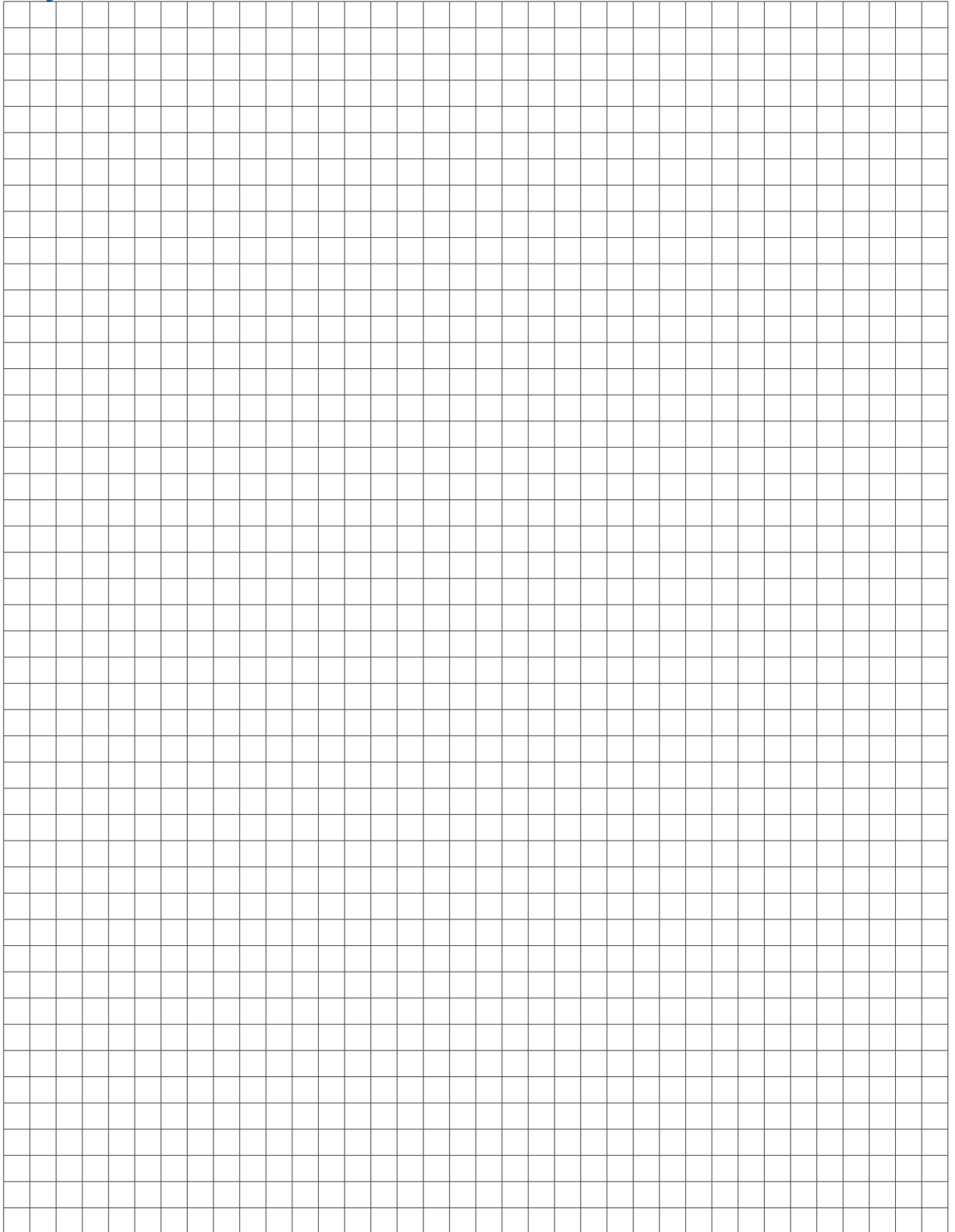

Warranty

INFRARED HEATER

Beacon Morris (“the Manufacturer”) warrants to the original owner at the original installation site that the Beacon Morris Model Infrared Heater will be free from defects in material and workmanship for one (1) year from the date of shipment from the factory. If upon examination by the Manufacturer the Product is shown to have a defect in material or workmanship during the warranty period, the Manufacturer will repair or replace, at its option, that part of the product which is shown to be defective.

Extended warranty:

In addition to the warranty stated above the following models will have:

- RBS/RBU – Tubes shall be free from defects in material and workmanship for five (5) years from the date of shipment from the factory. Burner Head shall be free from defects in material and workmanship for ten (10) years from the date of shipment from the factory.
- RBD – Burner Head (including Emitter) shall be free from defects in material and workmanship for five (5) years from the date of shipment from the factory. Burner shall be free from defects in material and workmanship for one (1) year from the date of shipment from the factory.

This limited warranty does not apply:

- a) If the Product has been subjected to misuse or neglect, has been accidentally or intentionally damaged, has not been installed, maintained or operated in accordance with the furnished written instructions, or has been altered or modified in any way by an unauthorized person.
- b) To any expenses, including labor or material, incurred during removal or reinstallation of the Product.
- c) To any damage due to corrosion by chemicals, including halogenated hydrocarbons, precipitated in the air.
- d) To any workmanship of the installer of the Product.

This limited warranty is conditional upon:

- a) Advising the installing contractor, who will in turn notify the distributor or manufacturer.
- b) Shipment to the Manufacturer of that part of the Product thought to be defective. Goods can only be returned with prior written approval of the Manufacturer. All returns must be freight prepaid.
- c) Determination in the reasonable opinion of the Manufacturer that there exists a defect in material or workmanship.

Repair or replacement of any part under this Limited Warranty shall not extend the duration of the warranty with respect to such repaired or replaced part beyond the stated warranty period.

THIS LIMITED WARRANTY IS IN LIEU OF ALL OTHER WARRANTIES, EITHER EXPRESS OR IMPLIED, AND ALL SUCH OTHER WARRANTIES, INCLUDING WITHOUT LIMITATION IMPLIED WARRANTIES OF MERCHANTABILITY OR FITNESS FOR A PARTICULAR PURPOSE, ARE HEREBY DISCLAIMED AND EXCLUDED FROM THIS LIMITED WARRANTY. IN NO EVENT SHALL THE MANUFACTURER BE LIABLE IN ANY WAY FOR ANY CONSEQUENTIAL, SPECIAL, OR INCIDENTAL DAMAGES OF ANY NATURE WHATSOEVER, OR FOR ANY AMOUNTS IN EXCESS OF THE SELLING PRICE OF THE PRODUCT OR ANY PARTS THEREOF FOUND TO BE DEFECTIVE. THIS LIMITED WARRANTY GIVES THE ORIGINAL OWNER OF THE PRODUCT SPECIFIC LEGAL RIGHTS. YOU MAY ALSO HAVE OTHER RIGHTS WHICH MAY VARY BY EACH JURISDICTION.



260 NORTH ELM STREET, WESTFIELD, MA 01085 • TEL: (413) 562-5423

7555 TRANMERE DRIVE, MISSISSAUGA, ONTARIO L5S 1L4 CANADA • TEL: (905) 670-5888

