

MODEL FS-400

Formed Steel Louver • 4" Deep • 45° Straight Blades • Stationary • Galvanized Steel

Standard Materials and Construction

- FRAME:** 18-GA. galvanized steel.
- BLADE:** 18-GA. galvanized steel. Blades approximately 4 1/8" on centers.
- SCREEN:** (When indicated)
1/2" mesh, 19-GA. galvanized steel (.041").
- CONSTRUCTION:** Riveted and/or welded, full jambs with blades, head and sill contained within.

Options

- Flange Frame available.
- Finishes - Enamels, Epoxies, etc.
- Material - 304 or 316 Stainless steel
- Screens - Insect screen 1 8/16 aluminum mesh,
 - or- 1/2" flattened aluminum, .051",
 - or- 1/4" sq. mesh, 18-GA galvanized steel, .047",
 - or- 1/2" sq. mesh, 18-GA stainless steel, .047",
- Others available.

Notes

1. 1/2" nominal deduction will be made to the opening size given.
2. Approximate shipping weight is 7.0 lbs./sq.ft.

Louver Sizes

Min Panel	Max Single Panel
12"W x 12"H	60"W x 96"H

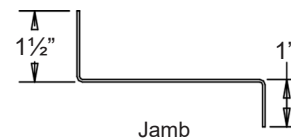
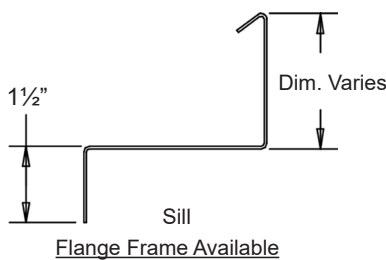
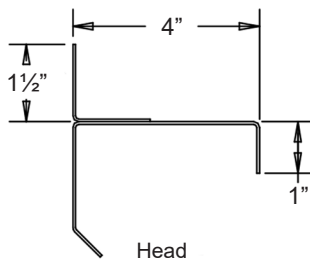
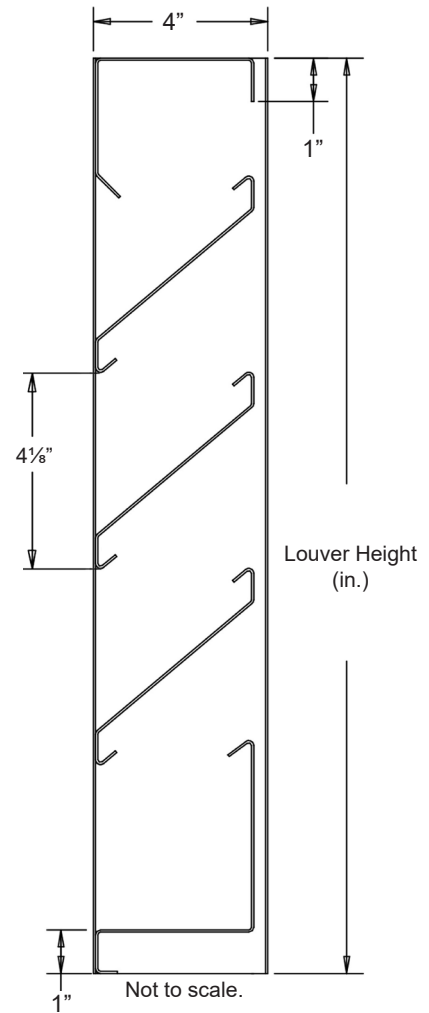
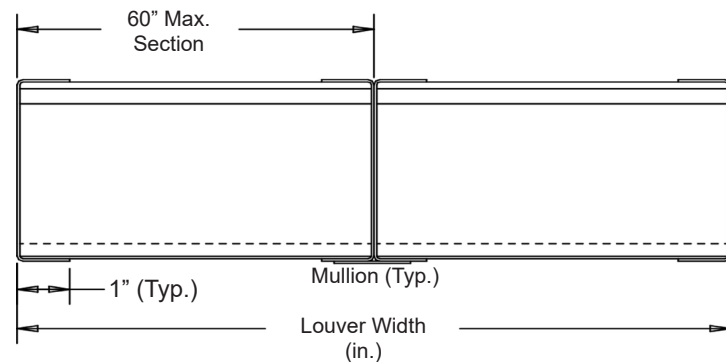

Item #	Qty	Width	Height	Width	Height	Mullion	Type	Location	Union Made
		Opening Size		Louver Size			Screens		
Arch. / Eng.:						EDR:	ECN:	Job:	
Contractor:									
Project:						Date:	DWN:	DWG:	

MODEL FS-400

Formed Steel Louver • 4" Deep • 45° Straight Blades • Stationary • Galvanized Steel

Performance Data

Pressure Drop: .08 in. w.g. at 630 fpm (Intake)
 Free Area: 8.11 sq.ft. = 51% for 48"W x 48"H sample tested in accordance with AMCA Standard 500-L.

Beginning Point of Water Penetration: 614 fpm

Ratings do not include effects of a screen.

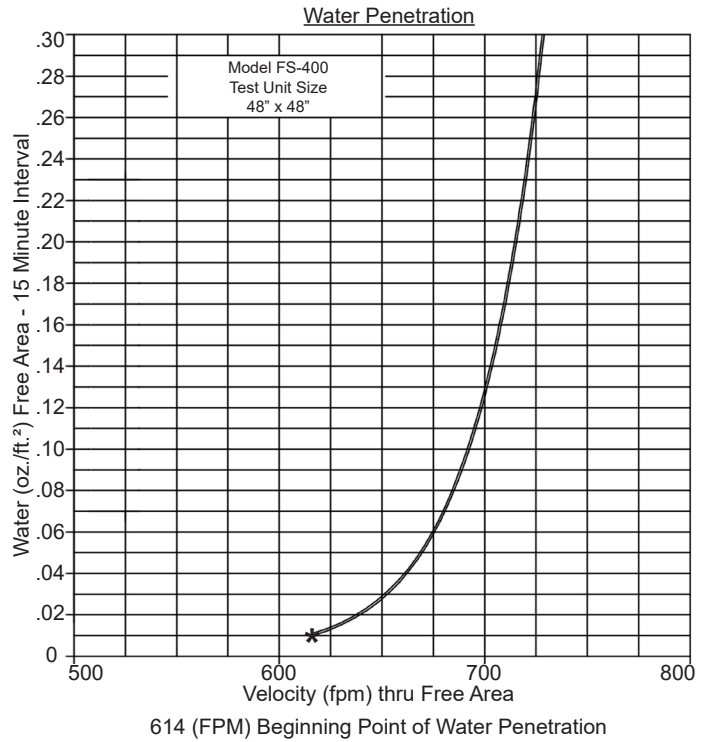
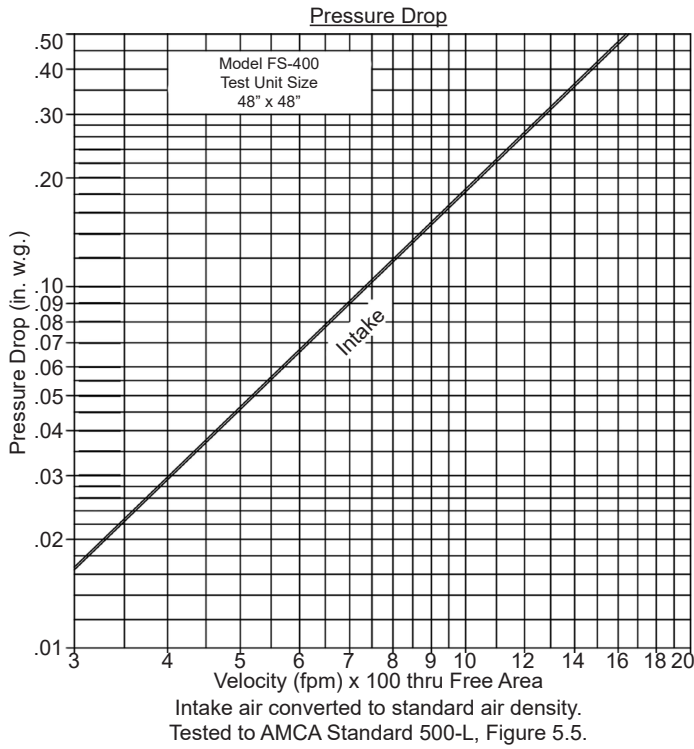

Free Area (sq.ft.)

		Width (in.)								
		12"	18"	24"	30"	36"	42"	48"	54"	60"
Height (in.)	12"	.26	.41	.57	.72	.87	1.03	1.18	1.34	1.49
	24"	.75	1.20	1.65	2.10	2.55	3.00	3.45	3.90	4.36
	36"	1.27	2.03	2.80	3.56	4.32	5.09	5.85	6.61	7.37
	48"	1.77	2.82	3.88	4.94	6.00	7.06	8.11	9.18	10.24
	60"	2.33	3.72	5.12	6.51	7.91	9.30	10.70	12.09	13.49
	72"	2.82	4.51	6.20	7.89	9.59	11.28	12.97	14.66	16.35
	84"	3.31	5.30	7.29	9.28	11.26	13.25	15.24	17.23	19.22
	96"	3.81	6.09	8.37	10.66	12.94	15.23	17.51	19.80	22.08



Arrow United Industries certifies that the Model FS-400 shown herein is licensed to bear the AMCA seal. The ratings shown are based on tests and procedures performed in accordance with AMCA Publication 511 and comply with the requirements of the AMCA Certified Ratings Program. The AMCA Certified Ratings Seal applies to Water Penetration and Air Performance Ratings only.