

Combination Mini-Fire/Smoke Damper • 1½ Hour Rated • Leakage Class I • Single Thickness Blade • Integrated Sleeve • 250°F or 350°F Rated • Galvanized Steel

Standard Materials and Construction

- FRAME:** 20 GA. galvanized steel flat by 18" long integral sleeve.
- BLADES:** 16 GA. galvanized steel single thickness, parallel action.
- AXLES:** Plated solid steel stub.
- BEARINGS:** Oil impregnated bronze.
- LINKAGE:** Galvanized steel angle interconnect, with plated steel brackets and pivots located on blade.
- STOPS:** 18 GA. galvanized steel at head and sill.
- BLADE SEALS:** Silicone.
- JAMB SEALS:** Stainless steel.
- SLEEVE:** Integral 20 GA. galvanized steel by 18" long.
- RETAINING ANGLES:** ¾" x 1½" x 16 GA. adjustable perimeter mounting angle.
- CAULKING:** Hardcast Irongrip 601 or UL-listed equivalent.
- FINISH:** Mill on galvanized steel.
- ACTUATOR:** Electric with heat response device (EHRD) or pneumatic with heat response device (PHRD). Factory-installed for power-open/spring-close (fail close) operation. External left-hand mounted as viewed from jackshaft side of damper.

Options

- Integral Dual Position Indication (IDPI) switches
- Sensotherm re-openable heat response device (ESOT) for electric actuator
- Sensotherm re-openable heat response device (PSOT) for pneumatic actuator
- Model SM-501 Flow-rated smoke detector shipped loose
- Model SM-501 Flow-rated smoke detector mounted and wired (6" minimum damper height with a 20" sleeve - extra 2" on jackshaft side)
- Tab-Lock retaining angles
- Stainless steel bearings
- Copper tubing (for pneumatic actuators)
- Optional 19" or 20" sleeve depth - Additional sleeve length is added to the non-jackshaft side unless ordered with mounted smoke detector and/or less than 6"H with B-Pan Transition
- Round or oval transitions
- Short-width (less than 16") and/or short-height (less than 6") transitions

Notes

1. "A" width and "B" height are opening dimensions. Damper frames are provided approximately ¼" undersized.
2. Dampers are available in 1" increments only.
3. Dampers for horizontal installation can only be mounted in a fire barrier constructed of masonry/concrete materials.
4. The blades must stay in the fire wall. The adjustable retaining angle may only be adjusted the distance shown on the label or installation instructions.

Damper Sizes

Orientation	Horizontal & Vertical	
	Minimum Panel	Maximum Panel
Rectangular	4"W x 4"H (6"W x 6"H frame)	24"W x 24"H
Round	4" dia. (6"W x 6"H frame)	22" dia.
Oval	4"W x 4"H (6"W x 6"H frame)	22"W x 22"H

*Dampers smaller than minimum frame size require a transition. Reference SD-TRFS. Dampers less than 6"H will have a 20" sleeve with the additional sleeve length on the jackshaft side when a B-Pan type transition is ordered.

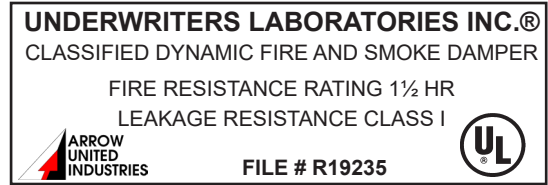

This combination fire/smoke damper meets the construction and performance requirements of:

- Underwriters Laboratories Inc. Standards 555 and 555S
- National Fire Protection Association Standards 80, 90A, 92, 101, 105
- ICC's International Building Code
- California State Fire Marshal Listing #3225-1328:120
- Underwriters Laboratories Inc. Approved for dual direction airflow and dynamic conditions.
- Underwriters Laboratories Inc. Classified for use in fire resistive ratings of less than 3 hours.
- Underwriters Laboratories Inc. Classified for use in smoke control systems for Leakage Class I and 250°F or 350°F.
- Actuators must be arranged to operate automatically, must fail closed upon loss of power, and must be controlled by a smoke detection system.

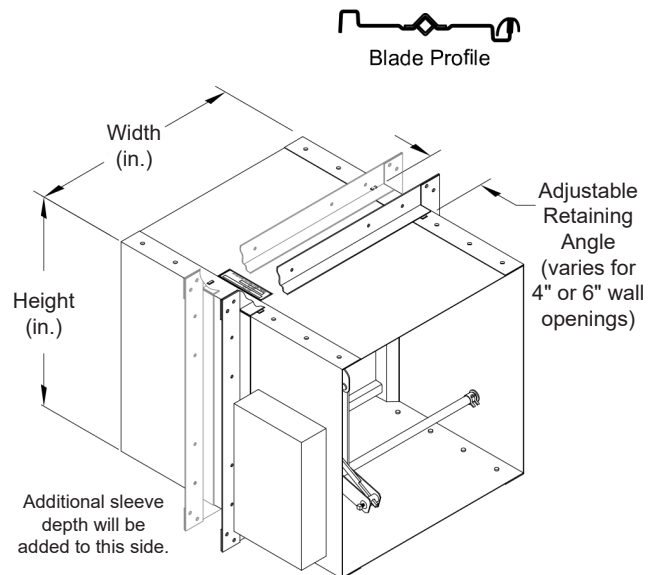

Combination Mini-Fire/Smoke Damper • 1½ Hour Rated • Leakage Class I • Single Thickness Blade • Integrated Sleeve • 250°F or 350°F Rated • Galvanized Steel

Operational Rating

Maximum Differential Pressure: 4 in. w.g.
Maximum Velocity: 2000 fpm

Leakage Rating

UL Class I
8 cfm per sq. ft. maximum @ 4 in. w.g.

Sound Rating

The Noise Criterion data below was tested in accordance with ASTM E477.99 in the center octave band.

Noise Criterion (NC)				
Damper Size	Velocity fpm (m/s)			
	1000 (5.08)	2000 (10.16)	3000 (15.24)	4000 (20.32)
12"W x 12"H (305mm x 305mm)	22dB	44dB	55dB	62dB

Pressure Drop Rating

The pressure drop data shown below is based on laboratory conditions. The test setup does not take into account elbows or other duct fittings that are part of every actual duct system. The configuration of the actual duct system immediately upstream and downstream of the damper often contributes more pressure loss than the damper itself.

12"W x 12"H

Velocity (FPM)	ΔP (in. w.g.)
500	0.01
1000	0.04
1500	0.09
2000	0.16
2500	0.25

24"W x 24"H

Velocity (FPM)	ΔP (in. w.g.)
500	0.01
1000	0.04
1500	0.08
2000	0.15
2500	0.23

This damper tested in accordance with AMCA 500-D, Figure 5.3

Intake air converted to standard air density.



Arrow United Industries certifies that the model AR1 damper shown here is licensed to bear the AMCA seal. The ratings shown are based on tests and procedures performed in accordance with AMCA Publication 511 and comply with the requirements of the AMCA Certified Ratings Program. The AMCA Certified Ratings Seal applies to Air Performance Ratings only.

Item #	Qty	Damper Size	Horizontal	Vertical	250°F	350°F	Velocity	Pressure		
			Orientation		Temp. Rating		Operational Rating			Union Made
Arch. / Eng.:					EDR:		ECN:		Job:	
Contractor:										
Project:					Date:		DWN:		DWG:	