

MODEL AL-UF5

FEMA 361 Louver • 5½" Deep • Inverted V Blades • Stationary • Aluminum

Standard Materials and Construction

- FRAME:** ¼" aluminum plate.
- BLADE:** ¼" structural aluminum angle.
- FRAME DEPTH:** 5½" deep
- SCREEN:** ½" x 0.051" expanded aluminum
- FREE AREA:** 49.3% - 7.89 sq. ft. (48" x 48" Louver)
- PSF RATING:** 266 PSF Design Load
- TEST METHODS:** ICC 500, FEMA 361, ASTM E 330, ASTM E 1886

AVAILABLE FINISHES: Mill, Kynar

Test Methods

ICC 500-2014, Standard for the Design and Construction of Storm Shelters.

FEMA 361 3rd Edition, Section B8 Test Methods for Impact and Pressure Testing.

ASTM E 330-02, Test Method for Structural Performance of Windows, Curtain Walls and Doors by Uniform Static Air Pressure Difference.

ASTM E 1886-05, Standard Test Method for Performance of Exterior Windows, Curtain Walls, Doors, and Impact Protective Systems Impacted by Missile and Exposed to Cyclic Pressure Differentials.

Notes

1. ½" nominal deduction will be made to the opening size given.
2. Keep occupants and mechanical equipment to a minimum of 3 feet away from the louver during severe weather events.
3. Approximate shipping weight is 15.0 lbs./sq.ft.

Louver Sizes

Min Panel	Max Single Panel
12"W x 12"H	90"W x 90"H (Continuous Wide) 78"W x 90"H (Continuous High)

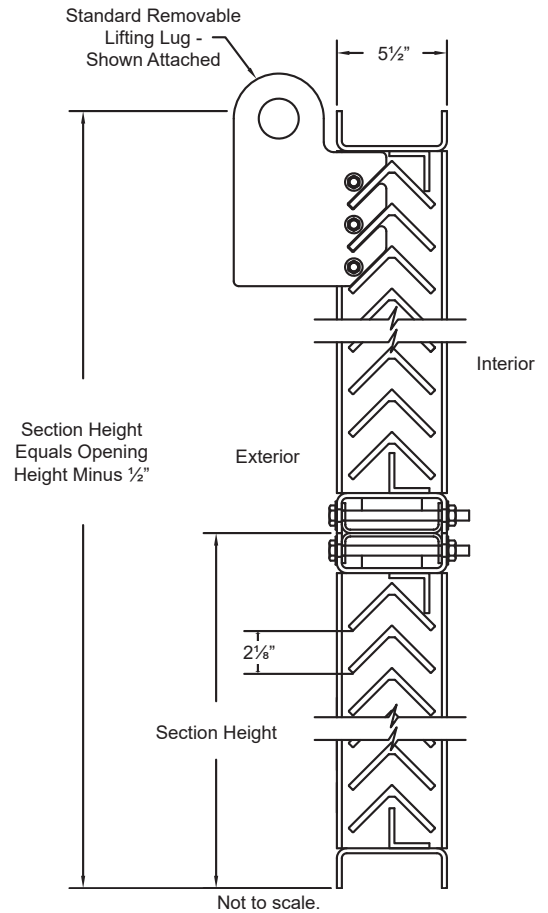

Optional Flange Mounting or Channel Frame Mounting

Standard Mount

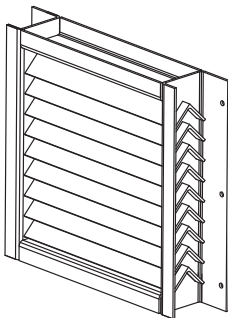

Cantilevered Mount
Flange at Jamb

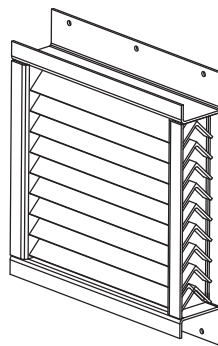

Cantilevered Mount
Flange at Head & Sill

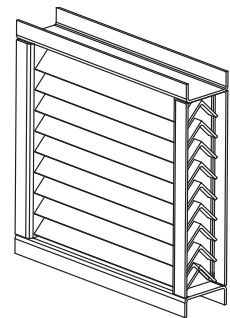

Recessed Mount
Channel Frame

Item #	Qty	Width	Height	Width	Height	Mullion	Type	Location	Union Made
		Opening Size		Louver Size			Screens		
Arch. / Eng.:						EDR:		ECN:	Job:
Contractor:									
Project:						Date:		DWN:	DWG:



MODEL AL-UF5

FEMA 361 Louver • 5½" Deep • Inverted V Blades • Stationary • Aluminum

Performance Data

		Free Area sq.ft. (sq.m.)								
		Width in. (mm)								
		12" (305)	24" (610)	36" (914)	48" (1219)	60" (1524)	72" (1829)	78" (1981)	84" (2134)	90" (2286)
Height in. (mm)	12" (305)	0.23 (0.021)	0.79 (0.073)	1.34 (0.124)	1.88 (0.175)	2.44 (0.277)	2.99 (0.278)	3.26 (0.303)	3.53 (0.328)	3.72 (0.345)
	24" (610)	0.47 (0.043)	1.63 (0.152)	2.76 (0.256)	3.88 (0.361)	5.05 (0.469)	6.18 (0.574)	6.74 (0.626)	7.30 (0.678)	7.68 (0.714)
	36" (914)	0.71 (0.066)	2.48 (0.230)	4.18 (0.389)	5.89 (0.547)	7.66 (0.711)	9.36 (0.870)	10.22 (0.949)	11.07 (1.028)	11.65 (1.082)
	48" (1219)	0.95 (0.088)	3.32 (0.308)	5.61 (0.521)	7.89 (0.733)	10.26 (0.953)	12.55 (1.166)	13.69 (1.272)	14.84 (1.378)	15.61 (1.450)
	60" (1524)	1.19 (0.111)	4.16 (0.387)	7.03 (0.653)	9.90 (0.920)	12.87 (1.196)	15.74 (1.462)	17.17 (1.595)	18.61 (1.728)	19.58 (1.819)
	72" (1829)	1.43 (0.133)	5.01 (0.465)	8.46 (0.786)	11.90 (1.106)	15.48 (1.438)	18.93 (1.758)	20.65 (1.918)	22.37 (2.078)	23.54 (2.187)
	78" (1981)	1.56 (0.145)	5.43 (0.504)	9.17 (0.852)	12.91 (1.199)	16.78 (1.559)	20.52 (1.906)	22.39 (2.080)	26.14 (2.429)	27.51 (2.555)
	84" (2134)	1.68 (0.156)	5.85 (0.543)	9.88 (0.918)	13.91 (1.292)	18.08 (1.680)	22.11 (2.054)	24.13 (2.241)	28.03 (2.604)	27.51 (2.555)
	90" (2286)	1.80 (0.167)	6.27 (0.583)	10.59 (0.984)	14.91 (1.385)	19.39 (1.801)	23.71 (2.202)	25.86 (2.403)	27.16 (2.523)	29.49 (2.739)

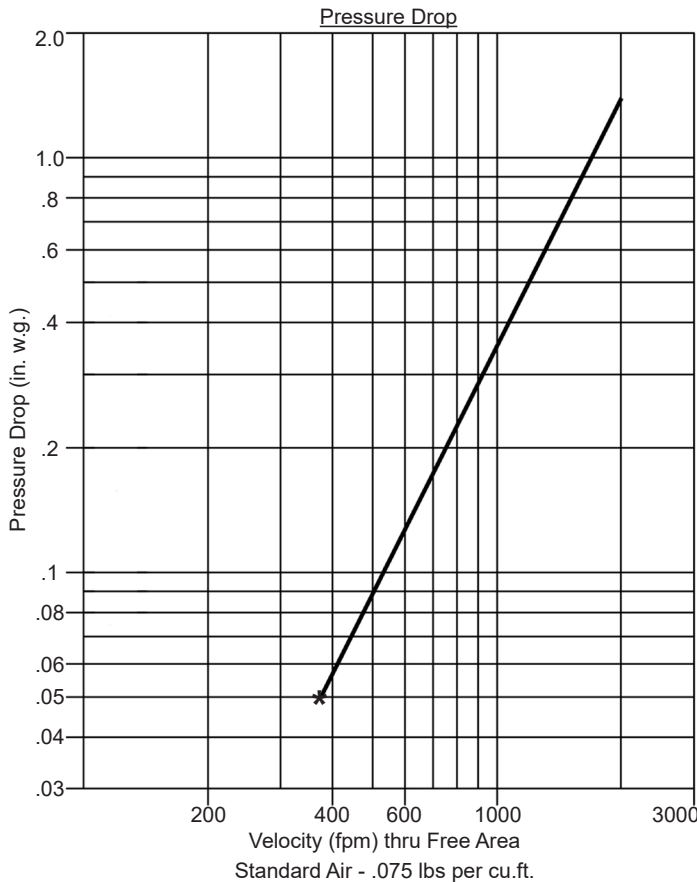

Ratings do not include the effect of a screen.
Tests based on a 48" x 48" test size.

Fastener Schedule

Anchor Type	Substrate	Minimum Embedment	Minimum Edge Dist.
(1) ½" x 3" Red Head LDT	CMU	2½"	¾"
(1) ½" x 3" Red Head LDT	Concrete	2½"	¾"
(2) 2" x ½" Grade 5 Bolt	Steel	Full	¾"

- (1) Concrete screws shall be Red Head LDT Zinc Coated Concrete Screws.
- (2) Bolts shall be a minimum Grade 5.

Note to Occupants:

Keep occupants and mechanical equipment to a minimum of 3 feet away from Model AL-UF5 louvers during severe weather events.

MODEL AL-UF5

FEMA 361 Louver • 5½" Deep • Inverted V Blades • Stationary • Aluminum

Louver Jamb Mounting Details

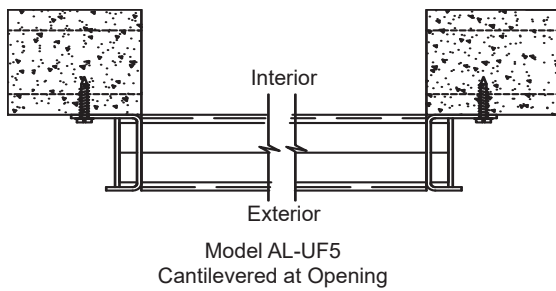
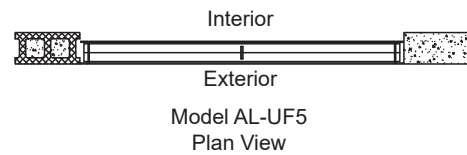
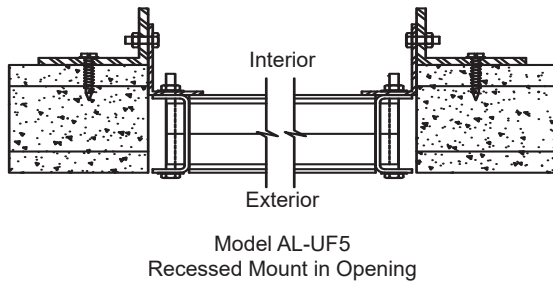
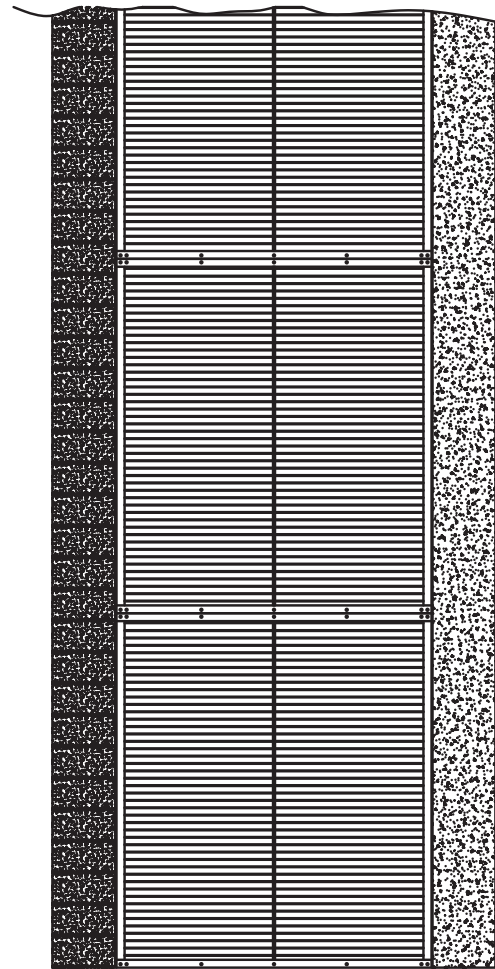
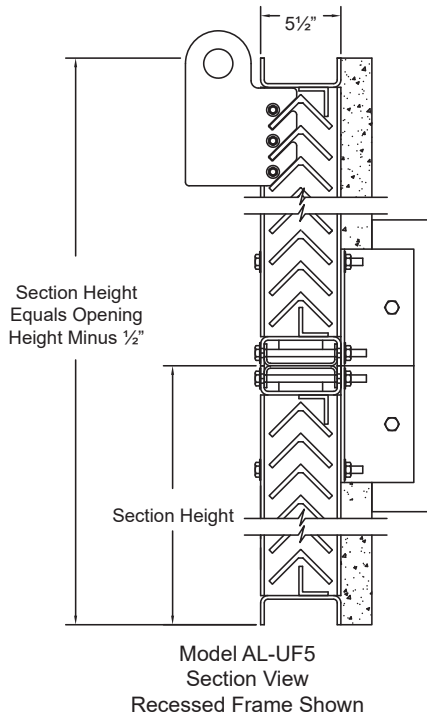

MODEL AL-UF5

FEMA 361 Louver • 5½" Deep • Inverted V Blades • Stationary • Aluminum

Louver Head and Sill Mounting Details

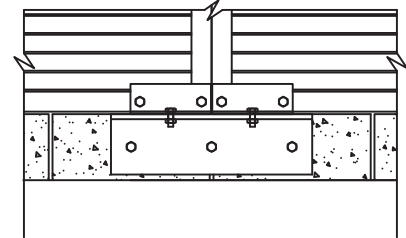
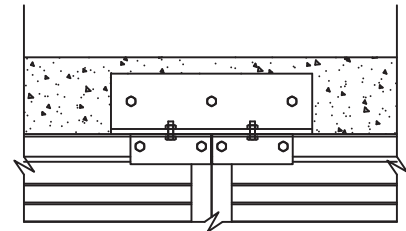
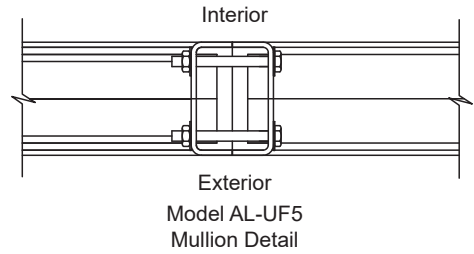
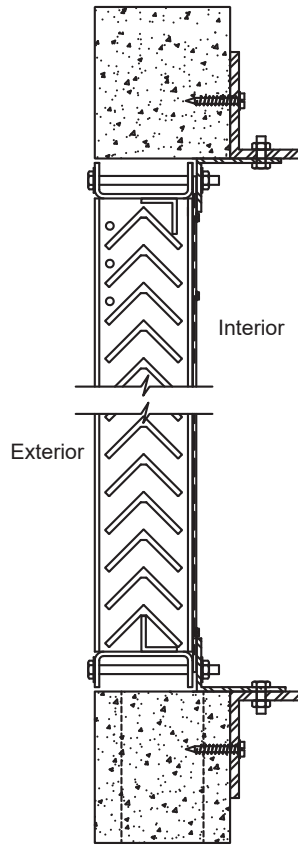
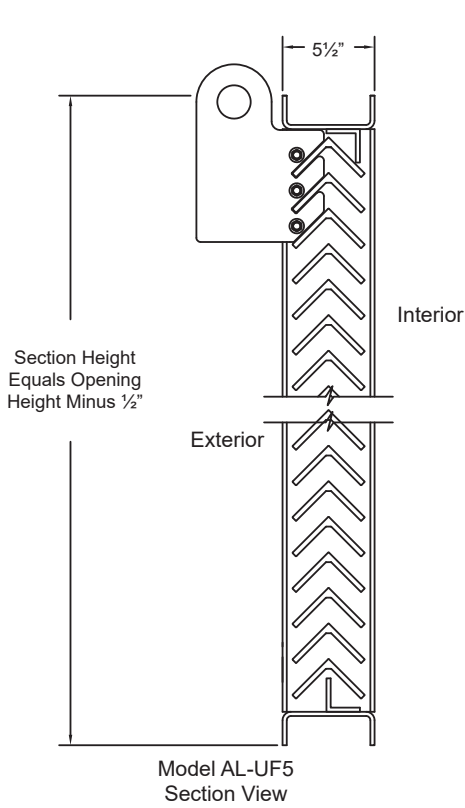

Model AL-UF5 Recessed in Opening Head and Sill Detail

