

UNITAIRE IV FAN COIL UNITS

FETF & FEFF

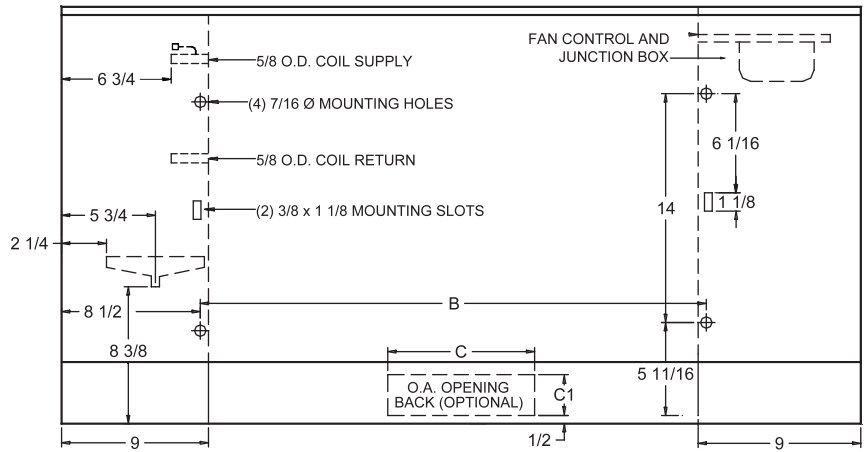
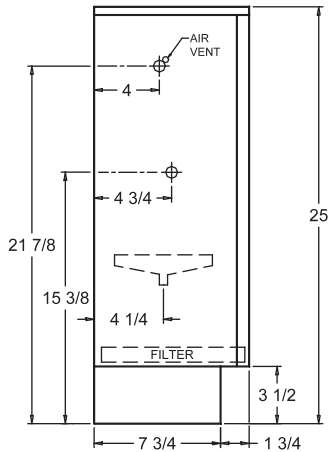
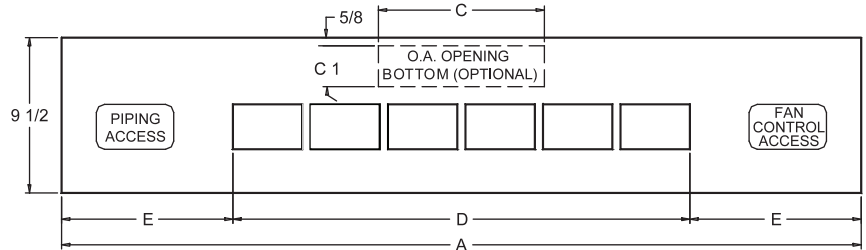

LEFT HAND PIPING CONNECTIONS SHOWN. RIGHT HAND OPPOSITE. PIPING HAND DETERMINED WHEN FACING AIR OUTLET
 ELECTRIC JUNCTION BOX LOCATION MAY VARY DEPENDING UPON CONTROL REQUIREMENTS. CONTACT FACTORY.
 FETF IS SHOWN. FEFF IS FURNISHED WITH AIR OUTLET, PIPING ACCESS AND FAN CONTROL ACCESS LOCATED IN FRONT PANEL.

DIMENSIONS								
UNIT SIZE	A	B	25% O.A. INTAKE		100% O.A. INTAKE		D	E
			C	C1	C	C1		
02	39	22	9	2-1/2	21	3	19-3/4	9-5/8
03	45	28	9	2-1/2	27	3	23-3/4	10-5/8
04	49	32	15	2-1/2	31	3	27-3/4	10-5/8
06	63	46	15	2-1/2	45	3	43-3/4	9-5/8
08	75	58	27	2-1/2	N/A	N/A	55-3/4	9-5/8
10/12	95	78	27	2-1/2	N/A	N/A	75-3/4	9-5/8

OPTIONAL 1-ROW AUXILIARY HEATING COIL

Coil connections
are 5/8" O.D. sweat

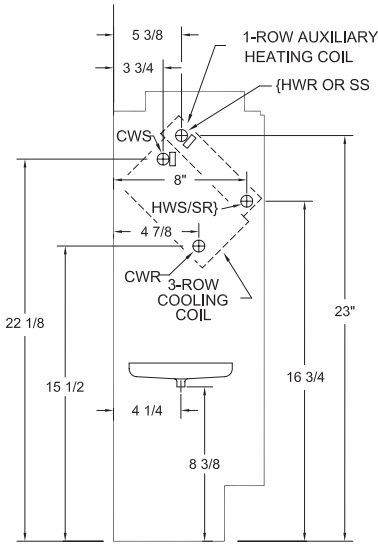

LEFT END VIEW

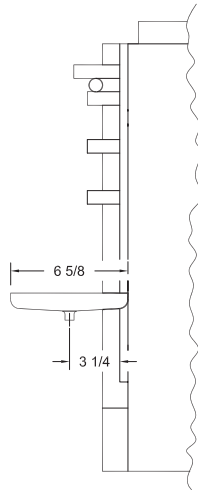

FRONT VIEW

LEGEND

CWS-CWR: Chilled Water Supply – Return
HWS-HWR: Hot Water Supply - Return
SS-SR: Steam Supply – Return

SPECIAL NOTES

1-Row Auxiliary Steam or Water Coil Connections may be "Same As" or "Opposite" Cooling Coil Piping. If "Opposite" is selected, the fan speed control must be located on the chilled water side or located remote from the unit.

CONTROL PACKAGES

Control Packages require Engineering Investigation for confirmation of adequate space allowance.

