

CRBR & CRBB Ceiling Recessed, Bottom Discharge

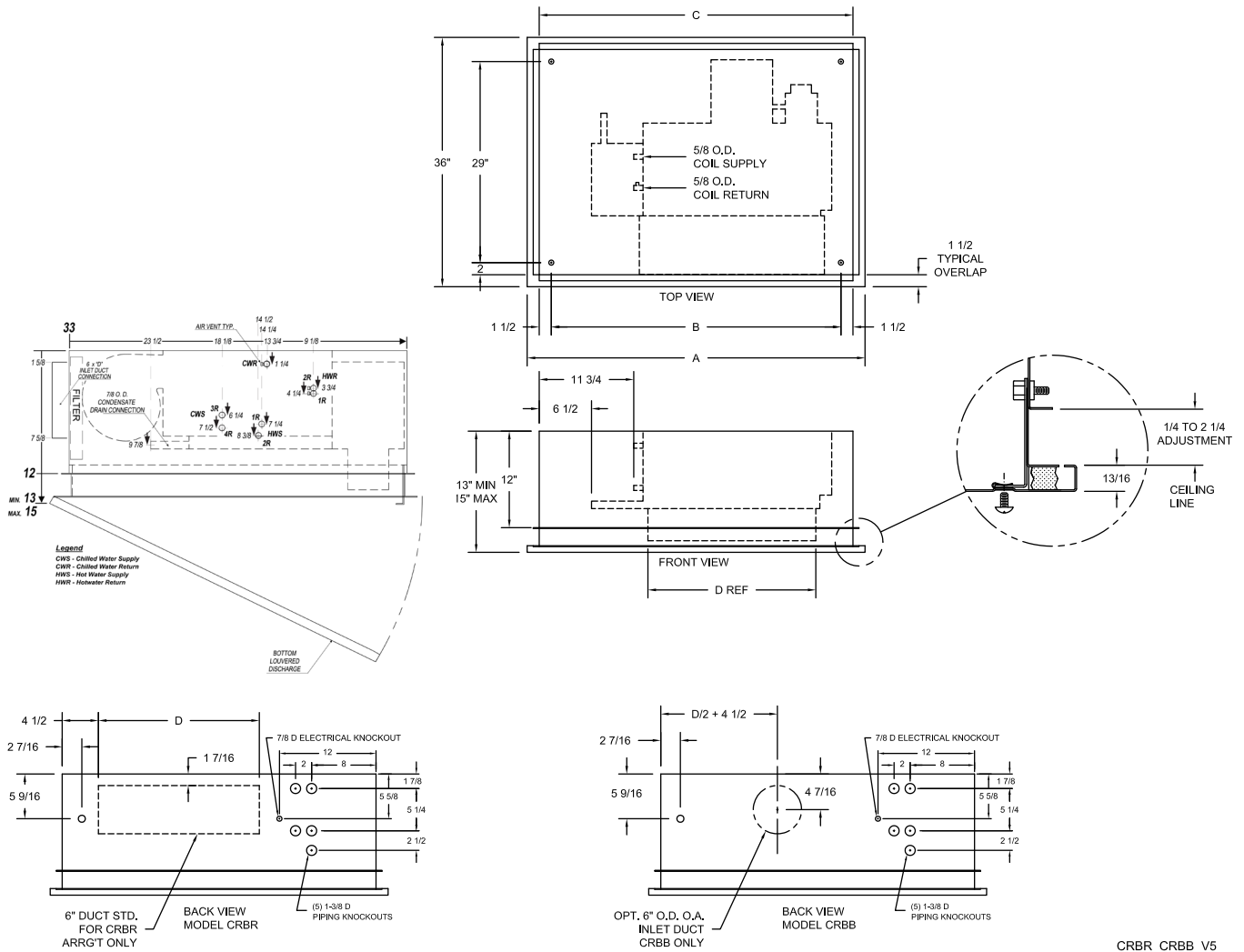

Left hand piping connections shown, right hand opposite. Piping hand determined when facing air outlet. Standard location of the electrical junction box is on the same side as the piping. Not available with electric heat.

UNIT SIZE	DIMENSIONS			
	A	B	C	D
02	42	36	39	20
03	48	42	45	26
04	52	46	49	30
06	66	60	63	44
08	78	72	75	56
10/12	98	92	95	76

Dimensions are approximate and are subject to change without notice.



260 North Elm Street, Westfield, MA 01085

Tel: (413) 568-9571

www.airthermhvac.com

PROJECT: _____ DATE: _____

LOCATION: _____

ARCHITECT: _____

ENGINEER: _____

CONTRACTOR: _____

PO NUMBER: _____

PHYSICAL DATA										
				UNIT SIZE						
				2	3	4	6	8	10	12
Air Inlet Opening – Minimum Free Area – Square Inches				67.6	81.2	94.9	149.6	190.7	259.1	259.1
Air Outlet Opening – Minimum Free Area – Square Inches				57.9	69.6	81.4	128.3	163.4	222.1	222.1
Filters			QTY.	1	1	1	1	1	2	2
SIZE-1" X 9" X			Length (In.)	20 7/8	26 7/8	30 7/8	44 7/8	56 7/8	40 & 30 7/8	40 & 30 7/8
Fans	Wheel	QTY		1	1	2	21	3	4	4
		Diameter (In.)		5.72	5.72	5.72	5.72	5.72	5.72	5.72
		Width (In.)		7.875	7.875	7.875	7.875	7.875	7.875	7.875
		Type		Double Width – Double Inlet – Forward Curve						
	Construction		U.L. Rated Plastic Fan – Dynamically Balanced							
	Housing	Width (In.)		9.175						
Construction		Galvanized Steel								
Coils	Air Vent		Manual Air Vent Furnished On All Coils							
	Tube Diameter		1/2" Seamless Copper							
	Connection Size		5/8" O.D. Sweat							
	Test Pressure		450 PSI							
	Working Pressure		300 PSIG Maximum							
	Depth 3-ROW		3 1/4							
	Depth 4-ROW		4 3/8							
	Width (In.)		7.5							
	Length (In.)		15 1/12	22 1/2	26 1/2	40 7/8	53 7/8	72 5/8	72 5/8	
	Face Area (Sq. Ft.) 3 & 4-Row		0.81	1.2	1.4	2.1	2.8	3.8	3.8	
	Fin Material		Aluminum							
	FPI		10.5				12			
	Water Vol. Gal. 3-Row		0.41	0.5	0.56	0.75	0.93	1.22	1.22	
	Water Vol. Gal. 4-Row		0.55	0.67	0.75	1	1.24	1.62	1.62	

UNITAIRE 5 FAN COILS EXPOSED NON-DUCTED UNITS Capacity Performance Chart								
		UNIT SIZE						
		02	03	04	06	08	10	12
PRIMARY COILS		Cooling EAT-80*DB/67*WB_EWT/LWT-45/55						
3-ROW	Tot/Sen GPM	7.6/5.7 1.5	8.2/6.2 1.6	10.9/8.2 1.2	13.5/10.2 2.7	19.8/14.9 1.2	19.3/14.5 3.9	27.2/20.5 5.5
4-ROW	Tot/Sen GPM	9.5/7.2 1.9	9.5/7 1.8	12.2/9.5 2.5	15.4/11.6 3.1	22.6/17 4.5	22.5/17 4.5	31.2/23.5 6.2
HEATING COILS		Heating EAT-70*DB_EWT/LWT-180/160						
1-ROW	Sen GPM	10.5 1.1	14.6 1.5	18.2 1.9	21.2 2.2	27.3 2.8	35 3.6	38.3 4
2-ROW	Sen GPM	14.5 1.5	20 2.1	24.9 2.6	27.2 2.7	35.2 3.5	43.3 4.5	47.5 4.9
3-ROW	Sen GPM	18.4 1.9	25.4 2.6	31.6 3.3	43 4.5	50 5.2	64.2 6.7	70.3 7.3
4-ROW	Sen GPM	20 2.1	27.7 2.9	34.5 3.6	47 4.9	57.7 6	74 7.7	81 8.4
CFM Range		90-260	100-320	150-480	150-588	210-780	250-1000	380-1250
WATTS		28	28	35	55	60	88	180

Heating Capacity based on:

EAT = 70°F

EWT = 180°F

LWT = 160°F

High Fan Speed

Air Flow Curves

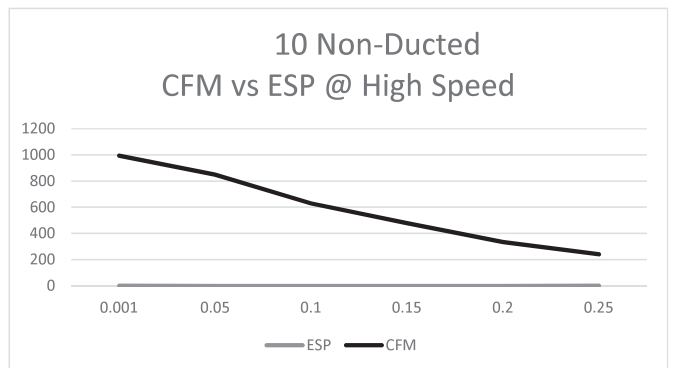
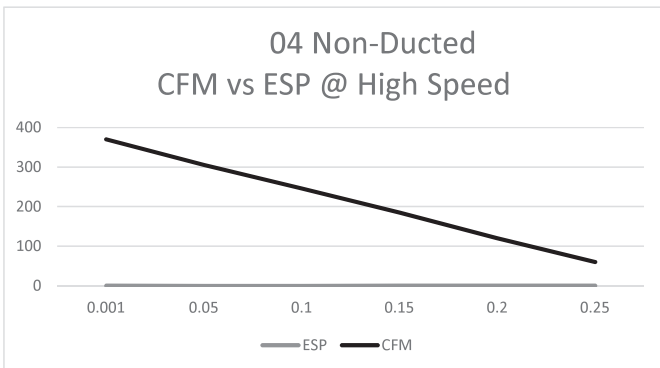
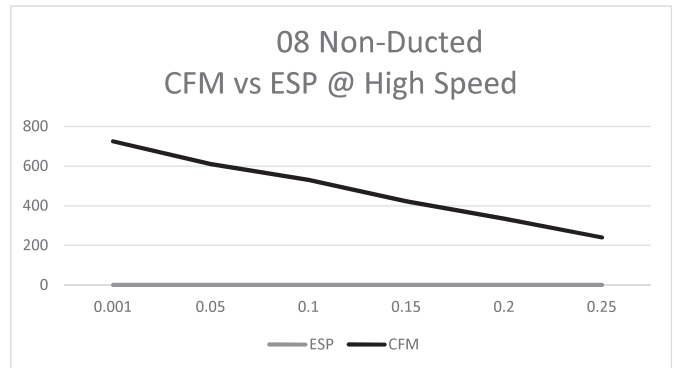
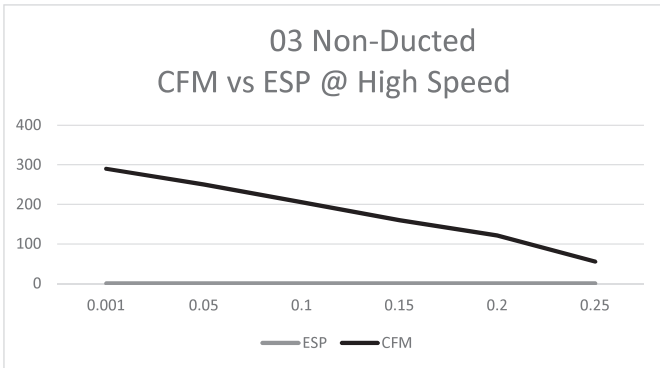
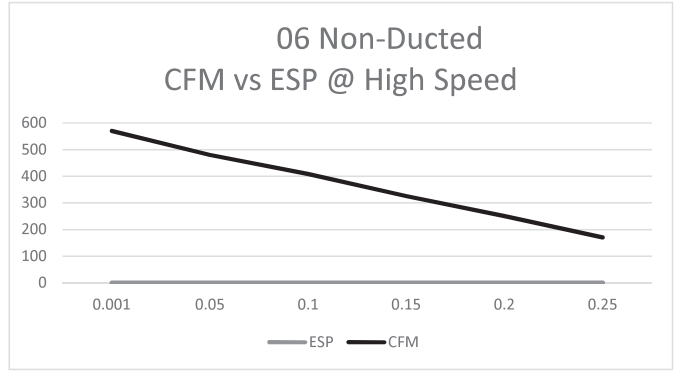
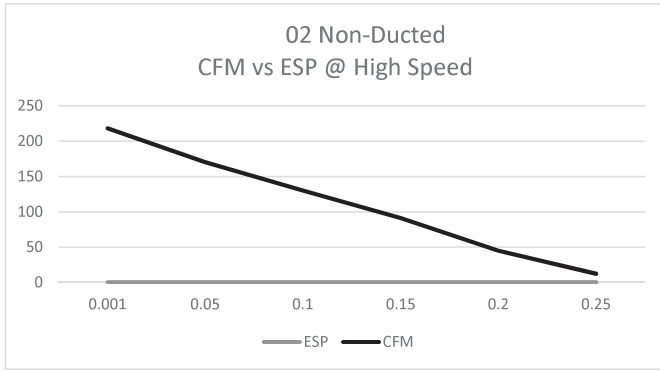

UNITAIRE FAN COIL UNITS

OCTAVE BAND SOUND POWER RATINGS

(DB RE: 10⁻¹² WATTS)

Tabulated below is the sound power data for Airtherm Unitaire fan coil units. Riverbank Acoustical Laboratory located in Geneva, Illinois has conducted independent sound power tests for Airtherm. The facilities and measurement techniques were in complete accordance with ARI Standard 350-86. The standard output of the ILG Source is that indexed in ASTM E336-67T.

UNIT SIZE	MOTOR SPEED	MOTOR RPM	CFM	OCTAVE BAND						
				2	3	4	5	6	7	8
				CENTER FREQUENCY (CPS)						
				125	250	500	1000	2000	4000	8000
021	HIGH	1010	240	52	53	45	43	39	35	34
	MED	950	220	49	50	42	40	36	32	31
	LOW	750	175	44	45	37	35	31	27	26
031	HIGH	1060	310	50	55	49	47	44	37	30
	MED	950	275	47	52	46	44	41	34	27
	LOW	750	220	42	47	41	39	36	29	22
041	HIGH	1060	400	50	52	50	46	42	34	33
	MED	950	350	47	49	47	43	39	31	30
	LOW	750	280	38	44	42	38	34	26	25
061	HIGH	1060	600	53	58	52	51	47	41	37
	MED	950	535	50	55	49	48	44	38	34
	LOW	750	425	45	50	44	43	39	33	29
081	HIGH	1070	800	52	56	51	51	48	39	32
	MED	950	710	49	53	48	48	45	36	29
	LOW	750	560	44	48	43	43	40	31	24
101	HIGH	1070	1060	55	60	53	52	49	42	36
	MED	950	900	52	57	50	49	46	39	33
	LOW	750	710	47	45	45	44	41	34	28
121	HIGH	1220	1170	52	57	51	50	46	40	36
	MED	1100	1065	---	---	---	---	---	---	---
	LOW	830	800	44	49	43	42	38	32	28