

STANDARD MATERIALS AND CONSTRUCTION

- FRAME:** 18-GA. galvanized steel.
- BLADE:** 18-GA. galvanized steel. Blades approximately 4 1/8" on centers.
- SCREEN:** (When indicated)
1/2" mesh, 19-GA. galvanized steel (.041").
- CONSTRUCTION:** Riveted and/or welded, full jambs with blades, head and sill contained within.

OPTIONS

- Flange Frame available.
- Finishes - Enamels, Epoxies, etc.
- Screens - Insect screen 1 8/16 aluminum mesh,
-or- 1/2" flattened aluminum, .051",
-or- 1/4" sq. mesh, 18-GA galvanized steel, .047",
-or- 1/2" sq. mesh, 18-GA stainless steel, .047",
Others available.

NOTES

1. Nominal deductions will be made to the opening size given.
2. Approximate shipping weight is 7.0 lbs./sq.ft.

LOUVER SIZES

Min Panel	Max Single Panel
12"W x 12"H	60"W x 96"H

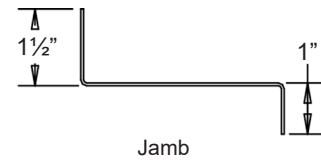
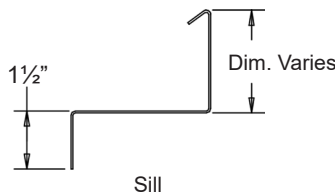
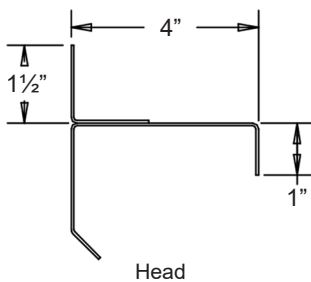
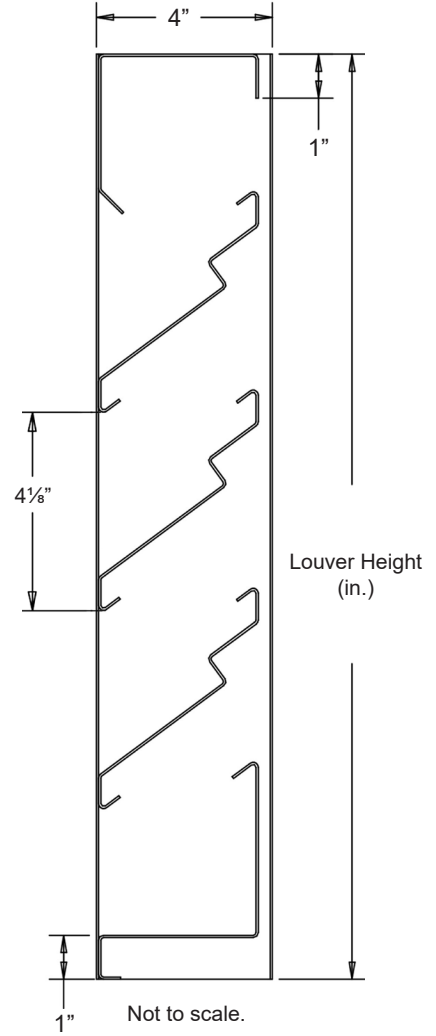
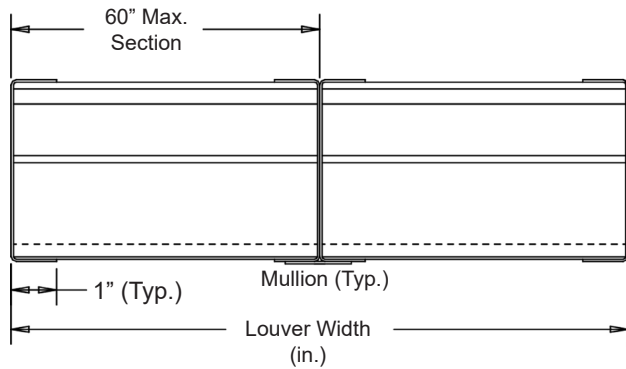

Flanged Frame Available

												
Item #	Qty	Width	Height	Width	Height	Mullion	Type	Location				
Arch. / Eng. :		Opening Size		Louver Size		EDR:	Screens		ECN:	Job:		
Contractor:						Date:	DWN:	DWG:				

PERFORMANCE DATA

Pressure Drop: .07 in. w.g. at 650 fpm (Intake)
 Free Area: 8.25 sq.ft. = 51.6% for 48"W x 48"H sample tested in accordance with AMCA Standard 500-L.
 Beginning Point of Water Penetration: 643 fpm

Ratings do not include effects of a screen.

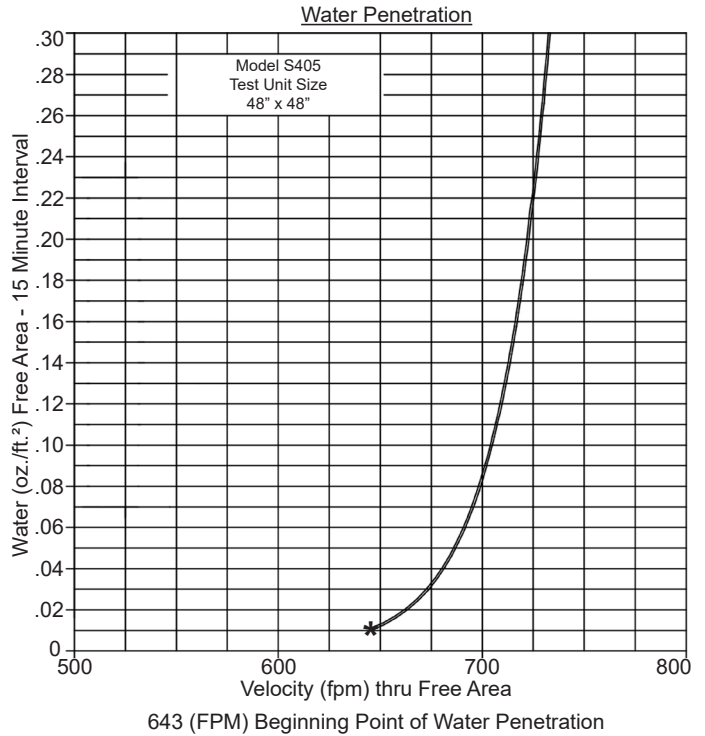
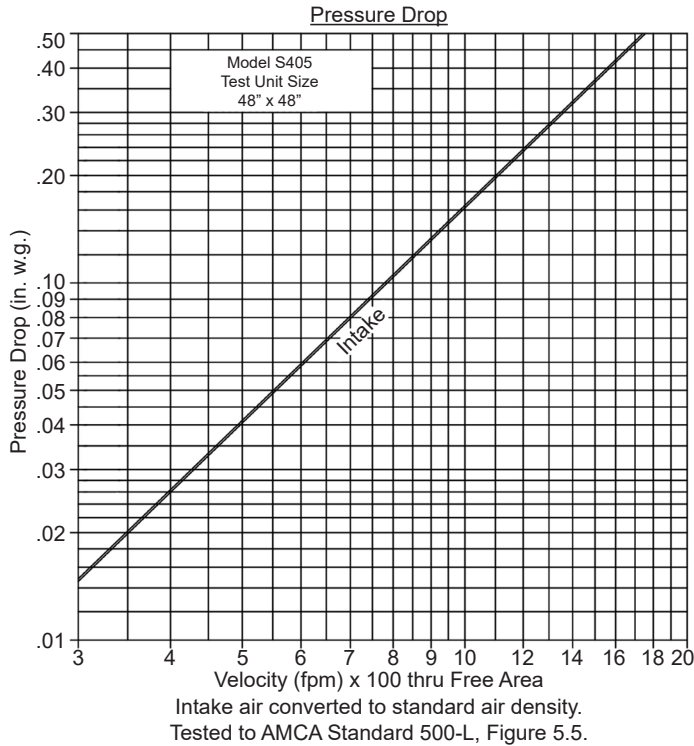

Free Area (sq.ft.)

		Width (in.)								
		12"	18"	24"	30"	36"	42"	48"	54"	60"
Height (in.)	12"	.26	.41	.57	.72	.87	1.03	1.18	1.34	1.49
	24"	.78	1.25	1.71	2.18	2.65	3.12	3.58	4.05	4.52
	36"	1.27	2.03	2.80	3.56	4.32	5.08	5.85	6.61	7.37
	48"	1.76	2.82	3.88	4.94	6.00	7.05	8.25	9.17	10.23
	60"	2.32	3.72	5.11	6.50	7.89	9.29	10.68	12.07	13.47
	72"	2.81	4.50	6.19	7.87	9.56	11.25	12.94	14.62	16.31
	84"	3.30	5.28	7.26	9.24	11.21	13.19	15.17	17.15	19.13
96"	3.78	6.06	8.33	10.60	12.87	15.14	17.41	19.68	21.95	



Air Balance certifies that the Model S405 shown herein is licensed to bear the AMCA seal. The ratings shown are based on tests and procedures performed in accordance with AMCA Publication 511 and comply with the requirements of the AMCA Certified Ratings Program. The AMCA Certified Ratings Seal applies to Water Penetration and Air Performance Ratings only.