

Combination Fire-Smoke Damper ▲ 1½ Hour / 1 Hour Corridor Rated ▲ Leakage Class II ▲ Single Thickness Blades ▲ 250°F Rated ▲ Galvanized Steel

STANDARD MATERIALS AND CONSTRUCTION

- FRAME:** 5½" x 7⁄8" x 16 GA. galvanized steel hat channel.
- BLADES:** 16 GA. galvanized steel, parallel action.
- AXLES:** Plated solid steel stub.
- BEARINGS:** Oil impregnated bronze.
- LINKAGE:** Plated steel angle and crank plates with stainless steel pivots, in-jamb type.
- STOPS:** 20 GA. galvanized steel at head and sill.
- BLADE SEALS:** Silicone.
- JAMB SEALS:** Stainless steel.
- SLEEVE:** 20 GA. unflanged, 16" deep.
- CAULKING:** UL approved.
- ACTUATOR:** Electric with heat response device (EHRD). Factory-installed for power-open/spring-close (fail close) operation. Internal left hand mounted as viewed for jackshaft side of damper. Dampers less than or equal to 13" high external left hand mounted.
- FINISH:** Mill

OPTIONS

- Sleeve of various depths and gauges with ¾" flange on bottom side.
- Round or oval transitions
 - Top and bottom for unflanged sleeves; top only for flanged sleeves.
- 212°F fusible link.
- Perimeter mounting angles.
- External mounted actuator.
- Sensotherm re-openable heat response device (ESOT) for electric actuator.



NOTES

1. Damper frames are provided approximately ¼" undercut. The addition of a sleeve will increase the size of the assembly.
2. This damper is approved to be mounted either vertically (wall or partitions) or horizontally (floors) when used as a 1½ hour fire-smoke damper.



DAMPER SIZES

Orientation	Horizontal (floor) or Vertical (wall)		
Panels	Minimum Panel	Maximum Panel	Max Assy Panel
Rectangular	6"W x 6"H (8"W x 8"H frame)	24"W x 24"H	n/a
Round	6" dia. (8"W x 8"H frame)	22" dia.	n/a
Oval	6"W x 6"H (8"W x 8"H frame)	22"W x 22"H	n/a

UNDERWRITERS LABORATORIES INC.®
 CLASSIFIED CORRIDOR DAMPER
 FIRE RESISTANCE RATING 1 HR
 ALSO AS TO LEAKAGE RESISTANCE
 CLASS II 250°F
 FILE # R4708





UNDERWRITERS LABORATORIES INC.®
 CLASSIFIED FIRE AND SMOKE DAMPER
 FIRE RESISTANCE RATING 1½ HR
 LEAKAGE RESISTANCE CLASS II
 FILE # R4708

This fire/smoke damper meets the construction and performance requirements of

- Underwriters Laboratories Inc. Standards 555 and 555S
- National Fire Protection Association Standards 80 and 90A
- ICC's International Building Code
- California State Fire Marshal Listing #3226-1328:116
- Underwriters Laboratories Inc. Approved for dual direction airflow and dynamic conditions.
- Underwriters Laboratories Inc. Classified for use in fire resistive ratings of less than 3 hours.
- Underwriters Laboratories Inc. Classified for use in smoke control systems for Leakage Class II and 250°F.
- Actuators must be arranged to operate automatically, must fail closed upon loss of power, and must be controlled by a smoke detection system.

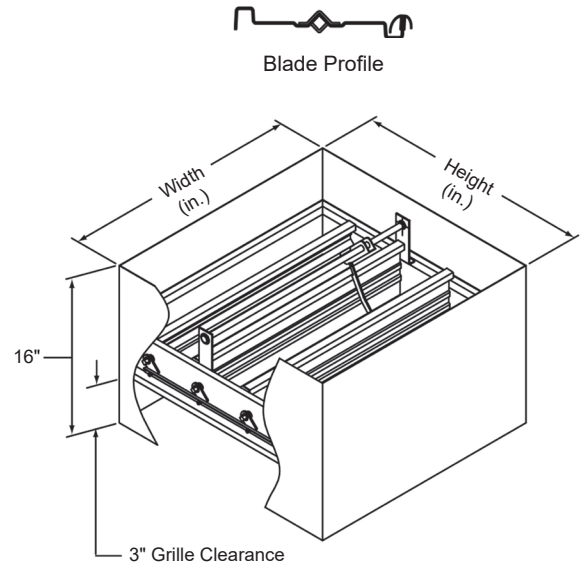

Combination Fire-Smoke Damper ▲ 1½ Hour / 1 Hour Corridor Rated ▲ Leakage Class II ▲ Single Thickness Blades ▲ 250°F Rated ▲ Galvanized Steel

OPERATIONAL RATING

Maximum Differential Pressure: 4 in. w.g.
Maximum Face Velocity: 2000 FPM

LEAKAGE RATING

UL Leakage Class II
10 CFM per sq.ft. maximum @ 1 in. w.g.
20 CFM per sq.ft. maximum @ 4 in. w.g.

SOUND RATING

The Noise Criterion data below was tested in accordance with ASTM E477.99 in the center octave band.

Damper Size	Noise Criterion (NC)			
	Velocity (fpm)			
	1000	2000	3000	4000
12"W x 12"H	31	53	64	71
24"W x 24"H	33	54	65	-

PRESSURE DROP RATING

The pressure drop data shown below is based on laboratory conditions. The test setup does not take into account elbows or other duct fittings that are part of every actual duct system. The configuration of the actual duct system immediately upstream and downstream of the damper often contributes more pressure loss than the damper itself.

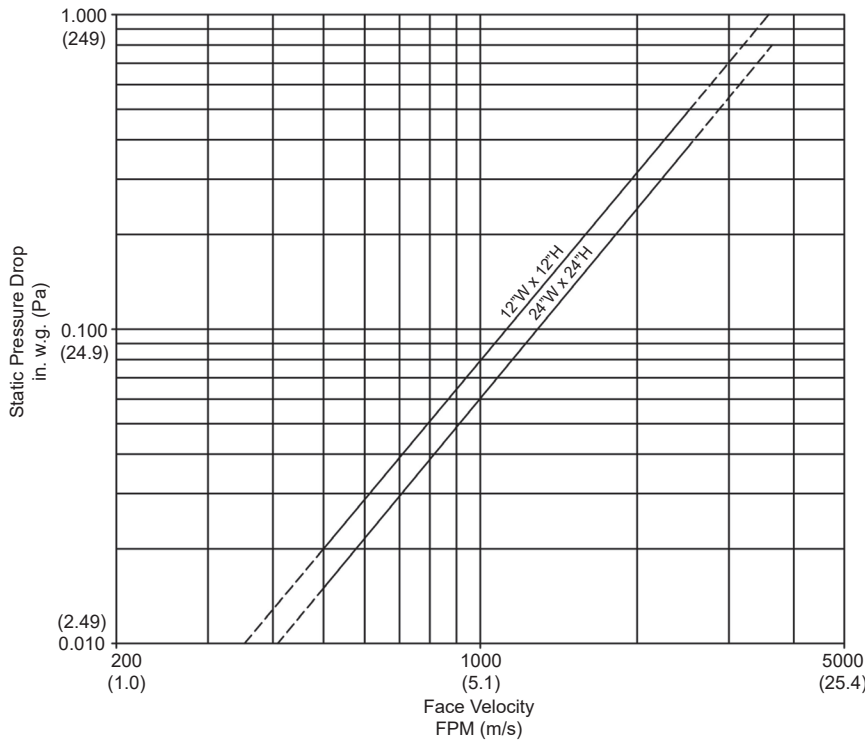

This product was tested in accordance with AMCA Standard 500D, Figure 5.3.

Intake air converted to standard air density.

									
Item #	Qty	Damper Size	Horizontal	Vertical	Fire-Smoke	Corridor	Velocity	Pressure	
			Orientation		Damper Type		Operational Rating		Union Made
Arch. / Eng.:					EDR:		ECN:		Job:
Contractor:									
Project:					Date:		DWN:		DWG: